

DCL-L 20.940.10

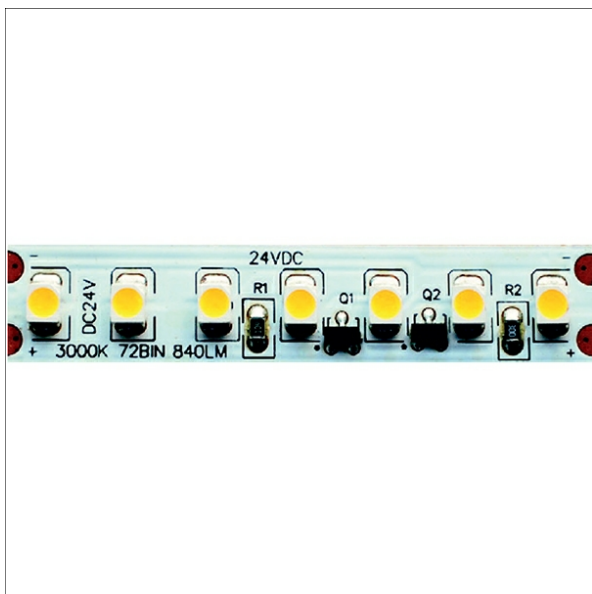

Farbe	Artikelnummer	EAN
	663833	4043544793454

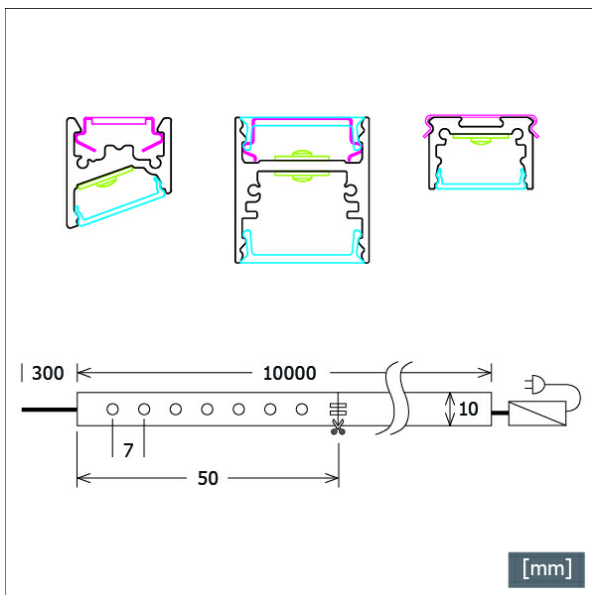

Beschreibung

- LED-Lichtband (Länge: 10 m) auf Rolle
- 140 LEDs pro Meter
- keine UV- und Wärmestrahlung
- nahezu alle Lichtbandlängen realisierbar
- kürzbar alle 50 mm
- Klebmontage in Profil
- Direktanschluss an geeigneten Konverter über Einspeisung mit Schneidklemmen
- Betriebsgerät (LED-Konverter) separat bestellen (Platzierung extern)

Hinweise

Die Angaben für Systemleistung, Lichtstrom und Systemeffizienz gelten jeweils für 1000 mm. Stellen Sie sicher, dass die zulässige Temperatur am Tc-Punkt nicht überschritten wird. Verwenden Sie deshalb nur die dafür vorgesehenen DecoLine Profile.

Standardoptionen

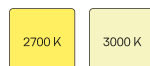

Lichttechnik / Normen

Leuchtmittel	LED Band / CRI 90 / 4000 K
EPREL Lichtquellen	1509103
Lebensdauer	L80 B50 40.000 h
Systemleistung	22.6 W
Leuchten-Lichtstrom	max. 1360 lm
Systemeffizienz	45.57 lm/W
Moduleffizienz	100.00 lm/W
UGR Klasse	>28
Abstrahlwinkel	110°
Versorgungsspannung	24 V DC
Schutzklasse	III
Schutzart	IP20

Abmessungen / Gewichte

Länge	10000 mm
Breite	10 mm
Höhe	3 mm
Nettogewicht	0.34 kg
Bruttogewicht	0.36 kg

DCL-L 20.940.10

DCL-L 20.940.10

DecoLine | LED Strip (AOB-A1, 1xLED 23W 940/4000K 1030lm)

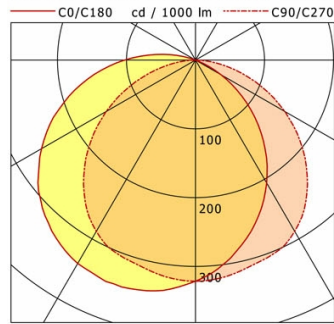

	C0	C90	C180	C270
0°	322	322	322	322
15°	273	310	345	310
30°	206	288	341	288
45°	125	228	312	228
60°	43	150	258	150
75°	0	65	186	65
90°	0	0	103	0
cd / 1000 lm				

LDC unsuitable for cone representation.
Asymmetric LDC.

η		LED
Efficiency		45 lm/W
Direct/Indirect		↓ 97% / ↑ 3%
System Power		23 W
UGR		X=4H, Y=8H
Reflection factors		70/50/20
UGR C0/C180		18.8
UGR C90/C270		28.5
CIE Flux Codes		44 75 92 97 100
Ra/CRI		>90

LTS

DCL-L 20.940.10

DecoLine | LED Strip (AKB-A1, 1xLED 23W 940/4000K 1360lm)

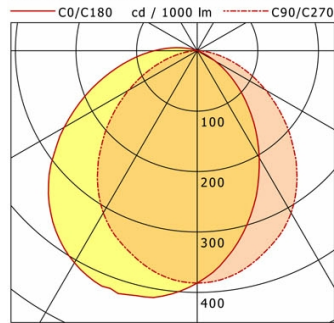

	C0	C90	C180	C270
0°	385	385	385	385
15°	305	362	419	362
30°	205	310	405	310
45°	109	224	347	224
60°	34	131	253	131
75°	0	51	154	51
90°	0	1	71	1
cd / 1000 lm				

LDC unsuitable for cone representation.
Asymmetric LDC.

η		LED
Efficiency		59 lm/W
Direct/Indirect		↓ 98% / ↑ 2%
System Power		23 W
UGR		X=4H, Y=8H
Reflection factors		70/50/20
UGR C0/C180		18.8
UGR C90/C270		28.4
CIE Flux Codes		49 79 94 98 100
Ra/CRI		>90

LTS

DCL-L 20.940.10

DecoLine | LED Strip (AOB-H1, 1xLED 23W 940/4000K 820lm)

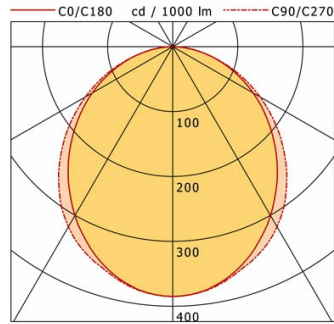

	C0	C90	C180	C270
0°	385	385	385	385
15°	361	364	361	364
30°	300	321	300	321
45°	223	245	223	245
60°	143	155	143	155
75°	65	66	65	66
90°	1	0	1	0
cd / 1000 lm				

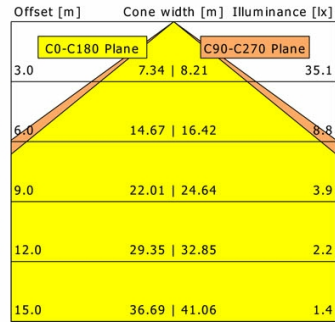

η		LED
Efficiency		36 lm/W
Direct/Indirect		↓ 100% / ↑ 0%
System Power		23 W
UGR		X=4H, Y=8H
Reflection factors		70/50/20
UGR C0/C180		27.6
UGR C90/C270		27.5
CIE Flux Codes		49 79 95 100 100
Ra/CRI		>90

LTS

DCL-L 20.940.10

DecoLine | LED Strip (AKB-H1, 1xLED 23W 940/4000K 1230lm)

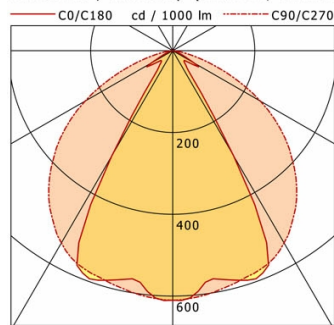

	C0	C90	C180	C270
0°	610	610	610	610
15°	581	588	581	588
30°	296	543	296	543
45°	40	422	40	422
60°	60	247	60	247
75°	9	59	9	59
90°	0	0	0	0
cd / 1000 lm				

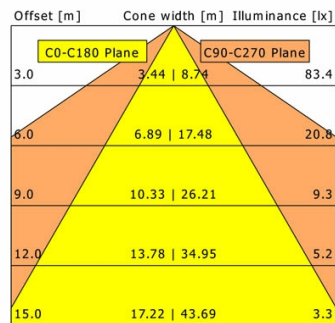

η		LED
Efficiency		53 lm/W
Direct/Indirect		↓ 100% / ↑ 0%
System Power		23 W
UGR		X=4H, Y=8H
Reflection factors		70/50/20
UGR C0/C180		19.8
UGR C90/C270		28.0
CIE Flux Codes		70 92 99 100 100
Ra/CRI		>90

LTS

DCL-L 20.940.10

DCL-L 20.940.10

DecoLine | LED Strip (AOV-H1, 1xLED 23W 940/4000K 890lm)

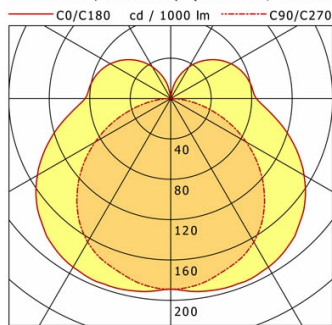

	C0	C90	C180	C270
0°	189	189	189	189
30°	193	164	193	164
60°	152	86	152	86
90°	85	1	85	1
120°	69	0	69	0
150°	36	0	36	0
180°	0	0	0	0
cd / 1000 lm				

LDC unsuitable for cone representation.
The C0 angle is oversized.

η	LED
Efficiency	39 lm/W
Direct/Indirect	↓ 77% / ↑ 23%
System Power	23 W
UGR	X=4H, Y=8H
Reflection factors	70/50/20
UGR C0/C180	30.4
UGR C90/C270	25.0
CIE Flux Codes	37 66 87 77 100
Ra/CRI	>90

LTS

DCL-L 20.940.10

Zubehör



CONV 024.035/DALI
LED-Konverter 35 W / dimmbar DALI



CONV 024.060
LED-Konverter 60 W / On-Off



CONV 024.060/DALI
LED-Konverter 60 W / dimmbar DALI



CONV 024.100
LED-Konverter 100 W / On-Off



CONV 024.100/DALI
LED-Konverter 100 W / dimmbar DALI



CONV 024.200
LED-Konverter 200 W / On-Off



DCL-Z100
Anschlussklemme



DCL-Z116
Verbinder elektrisch



DCL-Z117.1
Roller Standard

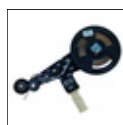

DCL-Z117.2
Roller Deluxe