

FLIR 200.2040.25

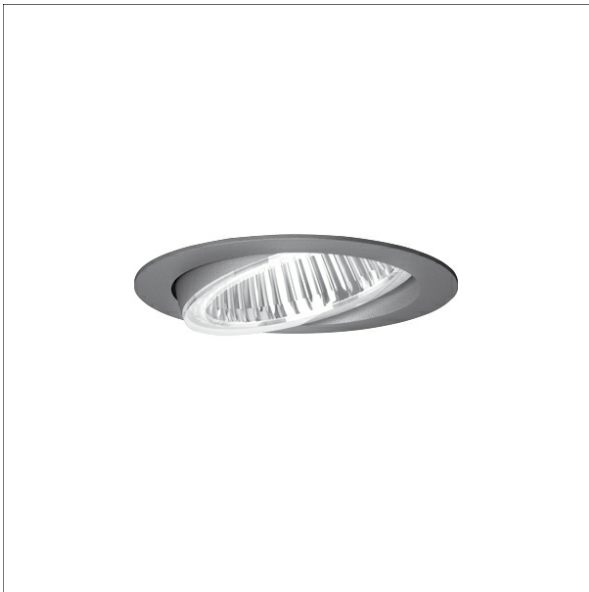

Farbe	Artikelnummer	EAN
schwarz	636601	4043544391834
silber	636602	4043544391841
weiß	636603	4043544391858

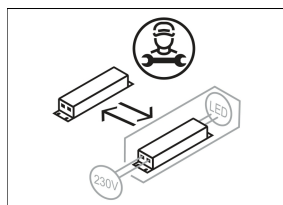
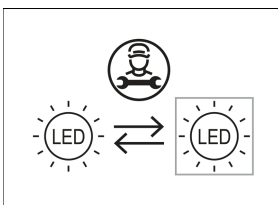
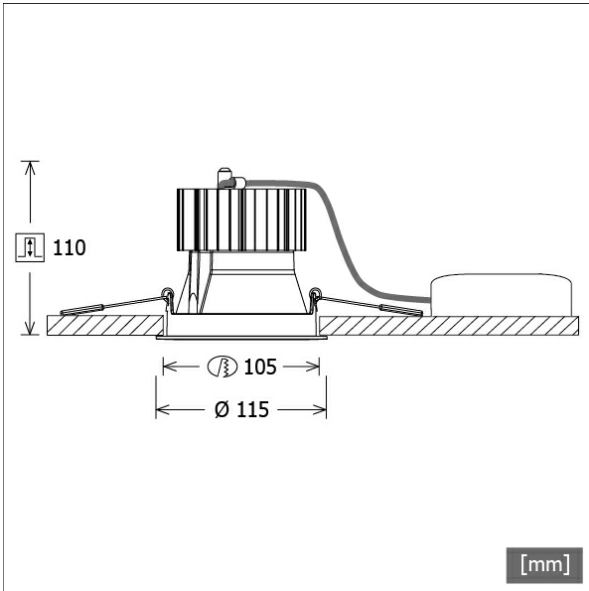

Beschreibung

- Einbaustrahler mit optischen Designvarianten und breitem Anwendungsspektrum
- Lichtkopf 20° schwenkbar
- hohe Wartungsfreundlichkeit
- keine UV- und Wärmestrahlung
- Wärmemanagement mit Passivkühlung (Kühlkörper aus Aluminium)
- High-Performance Spiegelreflektor aus Aluminium mit präziser symmetrischer Abstrahlcharakteristik für maximale Lichtausbeute und optimale Entblendung
- Front-/Einbauring aus Zinkdruckguss mit Lichteffektring klar (weitere Dekor-/Lichteffektringe und Dekogläser sind als Option erhältlich)
- werkzeugloser Deckeneinbau mit Schnellspannfedern (automatische Anpassung der Deckenstärke)
- Leuchte und Betriebsgerät über Kabel (Länge: 500 mm) fest verbunden, Betriebsgerät fertig für Netzanschluss
- Betriebsgerät (LED-Konverter) inklusive (Platzierung extern)

Standardoptionen



Sonderoptionen



Lichttechnik / Normen

Leuchtmittel	LED Spot / CRI 80 / 4000 K
EPREL Lichtquellen	848119
Lebensdauer	L90 B50 50.000 h
	L80 B50 100.000 h
	L80 B20 50.000 h
Systemleistung	27,0 W
Leuchten-Lichtstrom	max. 3110 lm
Systemeffizienz	115,18 lm/W
Moduleffizienz	160,37 lm/W
UGR Klasse	≤28
Abstrahlbereich	Medium Flood
Abstrahlwinkel	29°
Versorgungsspannung	220 - 240 V / 50 - 60 Hz
Schutzklasse	II
Schutzart	IP20

Abmessungen / Gewichte

Außendurchmesser	115 mm
Höhe	112 mm
Ausschnittsmaß (Ø)	105 mm
Deckenstärke	1,0 - 25,0 mm
Einbautiefe	110 mm
Nettogewicht	0,87 kg
Bruttogewicht	0,95 kg

FLIR 200.2040.25

FLIR 200.2040.25

Flixx 200 Round (FLIRZ 200.05, 1xLED 27W 840/4000K 3110lm 29°)

— C0/C180 cd / 1000 lm

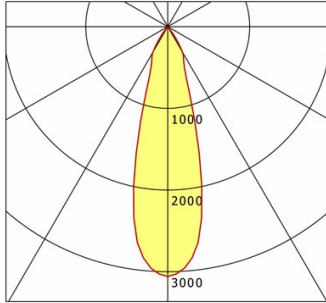

	C0	C90	C180	C270
0°	3059	3059	3059	3059
15°	1386	1386	1386	1386
30°	362	362	362	362
45°	16	16	16	16
60°	11	11	11	11
75°	5	5	5	5
90°	0	0	0	0
cd / 1000 lm				

Offset [m] Cone width [m] Illuminance [lx]

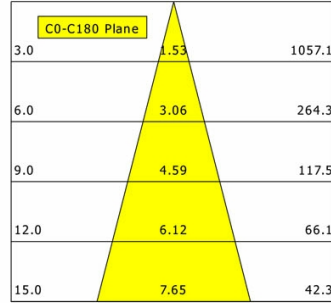

η	LED
Efficiency	115 lm/W
Direct/Indirect	↓ 100% / ↑ 0%
System Power	27 W
UGR	X=4H, Y=8H
Reflection factors	70/50/20
UGR C0/C180	19.8
UGR C90/C270	19.8
CIE Flux Codes	96 98 100 100 100
Ra/CRI	>80

LTS

FLIR 200.2040.25

Flixx 200 Round (FLIRZ 200.24, 1xLED 27W 840/4000K 2930lm 29°)

— C0/C180 cd / 1000 lm

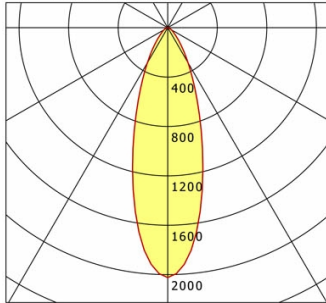

	C0	C90	C180	C270
0°	2024	2024	2024	2024
15°	1095	1095	1095	1095
30°	329	329	329	329
45°	93	93	93	93
60°	35	35	35	35
75°	15	15	15	15
90°	0	0	0	0
cd / 1000 lm				

Offset [m] Cone width [m] Illuminance [lx]

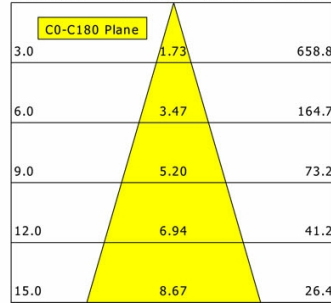

η	LED
Efficiency	109 lm/W
Direct/Indirect	↓ 100% / ↑ 0%
System Power	27 W
UGR	X=4H, Y=8H
Reflection factors	70/50/20
UGR C0/C180	25.9
UGR C90/C270	25.9
CIE Flux Codes	85 95 99 100 100
Ra/CRI	>80

LTS

FLIR 200.2040.25

Flixx 200 Round (FLIRZ 200.25, 1xLED 27W 840/4000K 3030lm 29°)

— C0/C180 cd / 1000 lm

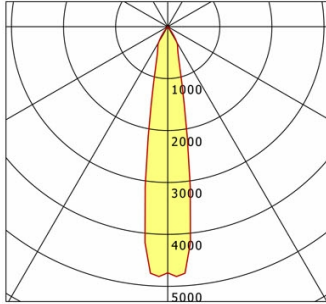

	C0	C90	C180	C270
0°	4741	4741	4741	4741
15°	983	983	983	983
30°	354	354	354	354
45°	18	18	18	18
60°	20	20	20	20
75°	5	5	5	5
90°	0	0	0	0
cd / 1000 lm				

Offset [m] Cone width [m] Illuminance [lx]

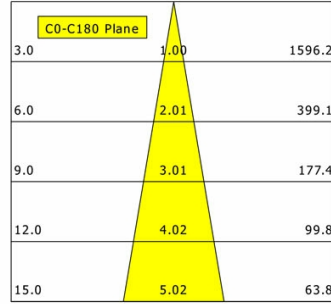

η	LED
Efficiency	113 lm/W
Direct/Indirect	↓ 100% / ↑ 0%
System Power	27 W
UGR	X=4H, Y=8H
Reflection factors	70/50/20
UGR C0/C180	20.1
UGR C90/C270	20.1
CIE Flux Codes	96 98 100 100 100
Ra/CRI	>80

LTS

FLIRZ 200.2040.25

Zubehör



FLIRZ 200.01
Dekorring schwarz



FLIRZ 200.02
Dekorring silber



FLIRZ 200.03
Dekorring weiß



FLIRZ 200.04
Lichteffektring opal



FLIRZ 200.05
Lichteffektring klar



FLIRZ 200.06
Lichteffektring rot matt



FLIRZ 200.07
Lichteffektring gelb matt



FLIRZ 200.08
Lichteffektring blau matt



FLIRZ 200.16
Lichteffektring rot transluzent



FLIRZ 200.17
Lichteffektring gelb transluzent



FLIRZ 200.18
Lichteffektring blau transluzent

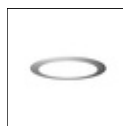

FLIRZ 200.24
Dekoglas opal



FLIRZ 200.25
Dekoglas klar