

STRL 607.0845.840/DALI

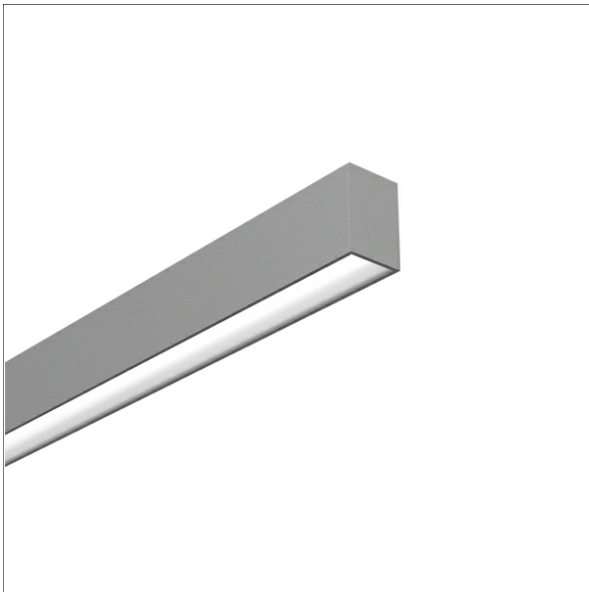

Farbe	Artikelnummer	EAN
silber eloxiert	667721	4043544770684
schwarz	667722	4043544770691
weiß	667723	4043544770707

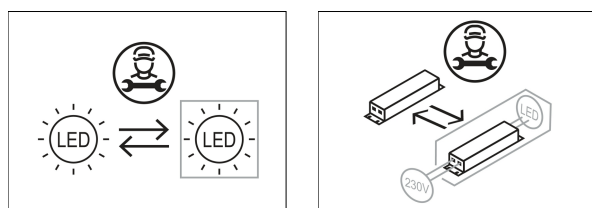
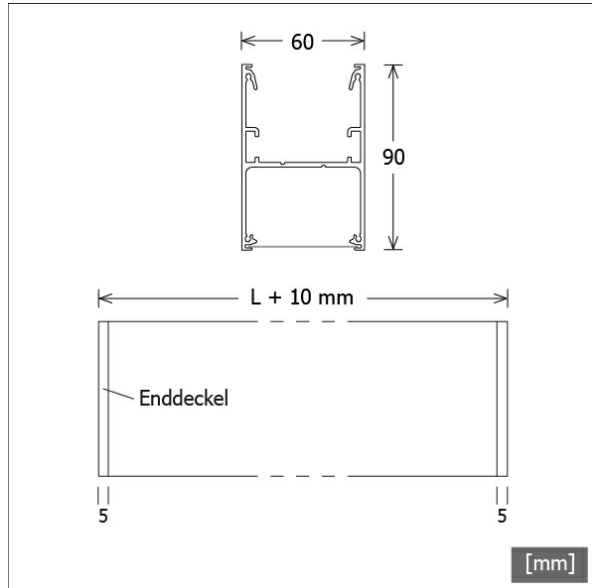

Beschreibung

- Lichtbandsystem für Decken- oder Pendelmontage
- Lichtmodule in verschiedenen Fixlängen zur Realisierung von variablen Lichtlinien (auch für sehr große Längen geeignet)
- hohe Wartungsfreundlichkeit
- keine UV- und Wärmestrahlung
- Modulgehäuse aus hochwertig extrudiertem Aluminiumprofil
- integriertes LED-Lichtband mit gewölbtem PMMA-Diffusor für homogene Lichtverteilung Lichtlenkung durch hocheffiziente nanoOptix-Folien von LTS mit Mikrolinsenstruktur und verschiedene Abstrahlcharakteristiken (Batwing/breitstrahlend, tiefstrahlend) oder über Standardfolie "opal diffus", LTS-nanoOptix-Folien sind optional erhältlich bis 150 m Länge (Vorteile: keine Stoßkanten, durchgängiges homogenes Lichtbild über die ganze Folienlänge)
- Enddeckel, Lichtlenkungsfolien und erforderliche Systemkomponenten separat bestellen
- Modul ohne Lichtlenkungsfolien
- Montage über Anbauklammern oder Drahtseilabhängung
- steckerfertig für Durchgangsverdrahtung
- Betriebsgerät (LED-Konverter DALI, dimmbar) integriert

Hinweise

Die thermische Längenausdehnung des Aluminiumprofils beträgt bei $\Delta T = 10$ Kelvin 0.3 mm pro Meter.

Standardoptionen



Sonderoptionen



Lichttechnik / Normen

Leuchtmittel	LED linear / CRI 80 / 4000 K
EPREL Lichtquellen	833900 833895
Lebensdauer	L90 B50 50.000 h L80 B50 100.000 h L80 B20 50.000 h
Systemleistung	11.8 W
Leuchten-Lichtstrom	max. 1360 lm
Systemeffizienz	100.84 lm/W
Moduleffizienz	187.83 lm/W
UGR Klasse	≤25
Versorgungsspannung	220 - 240 V / 50 - 60 Hz
Schutzklasse	I
Schutzart	IP20

Abmessungen / Gewichte

Länge	845 mm
Breite	60 mm
Höhe	90 mm
Nettogewicht	2.55 kg
Bruttogewicht	2.69 kg

STRL 607.0845.840/DALI

StraitLine | Light-Module (Opal Diffuse_si_wh, 1xLED 12W 840/4000K 1190lm)

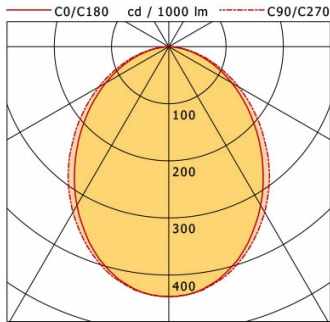

	C0	C90	C180	C270
0°	438	438	438	438
15°	405	410	405	410
30°	321	335	321	335
45°	220	238	220	238
60°	127	141	127	141
75°	51	57	51	57
90°	0	0	0	0
cd / 1000 lm				

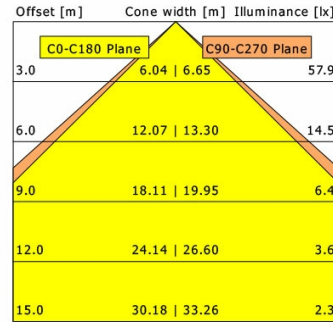

η	LED
Efficiency	99 lm/W
Direct/Indirect	↓ 100% / ↑ 0%
System Power	12 W
UGR	X=4H, Y=8H
Reflection factors	70/50/20
UGR C0/C180	22.7
UGR C90/C270	23.1
CIE Flux Codes	53 83 97 100 100
Ra/CRI	>80

LTS

StraitLine | Light-Module (Deep Beam nanoOptix_si_wh, 1xLED 12W 840/4000K 1280lm)

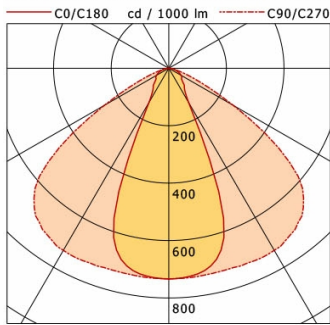

	C0	C90	C180	C270
0°	734	734	734	734
15°	673	730	673	730
30°	138	732	138	732
45°	70	662	70	662
60°	50	260	50	260
75°	23	33	23	33
90°	0	0	0	0
cd / 1000 lm				

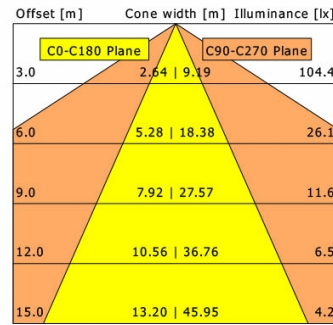

η	LED
Efficiency	107 lm/W
Direct/Indirect	↓ 100% / ↑ 0%
System Power	12 W
UGR	X=4H, Y=8H
Reflection factors	70/50/20
UGR C0/C180	16.9
UGR C90/C270	22.3
CIE Flux Codes	71 92 99 100 100
Ra/CRI	>80

LTS

StraitLine | Light-Module (Batwing/Wide Beam nanoOptix_si_wh, 1xLED 12W 840/4000K 1360lm)

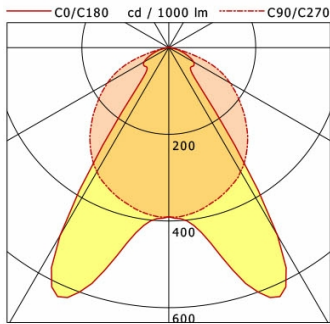

	C0	C90	C180	C270
0°	391	391	391	391
15°	515	373	515	373
30°	500	330	500	330
45°	71	252	71	252
60°	66	163	66	163
75°	25	46	25	46
90°	0	0	0	0
cd / 1000 lm				

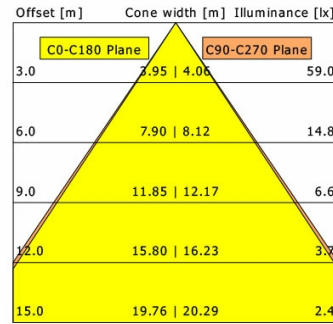

η	LED
Efficiency	113 lm/W
Direct/Indirect	↓ 100% / ↑ 0%
System Power	12 W
UGR	X=4H, Y=8H
Reflection factors	70/50/20
UGR C0/C180	18.6
UGR C90/C270	22.6
CIE Flux Codes	66 90 99 100 100
Ra/CRI	>80

LTS

StraitLine | Light-Module (Opal Diffuse_bk, 1xLED 12W 840/4000K 990lm)

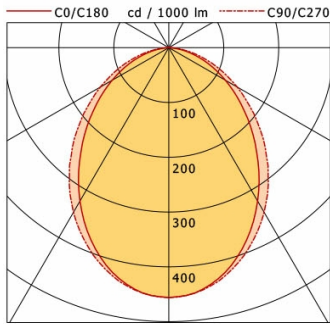

	C0	C90	C180	C270
0°	456	456	456	456
15°	418	424	418	424
30°	323	347	323	347
45°	214	246	214	246
60°	119	144	119	144
75°	45	57	45	57
90°	0	0	0	0
cd / 1000 lm				

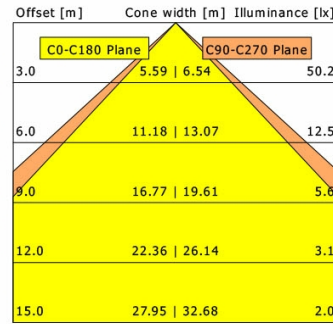

η	LED
Efficiency	83 lm/W
Direct/Indirect	↓ 100% / ↑ 0%
System Power	12 W
UGR	X=4H, Y=8H
Reflection factors	70/50/20
UGR C0/C180	21.5
UGR C90/C270	22.5
CIE Flux Codes	54 83 97 100 100
Ra/CRI	>80

LTS

STRL 607.0845.840/DALI

StraitLine | Light-Module (Deep Beam nanoOptix_bk, 1xLED 12W 840/4000K 1120lm)

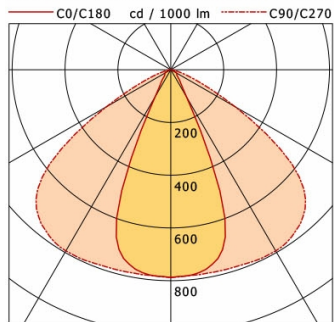

	C0	C90	C180	C270
0°	788	788	788	788
15°	725	786	725	786
30°	118	793	118	793
45°	36	721	36	721
60°	25	282	25	282
75°	9	32	9	32
90°	0	0	0	0
cd / 1000 lm				

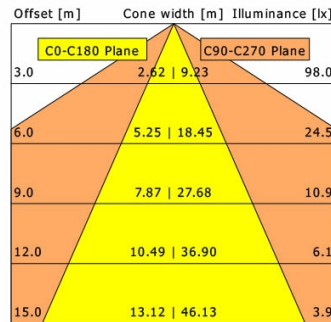

η	LED
Efficiency	93 lm/W
Direct/Indirect	↓ 100% / ↑ 0%
System Power	12 W
UGR	X=4H, Y=8H
Reflection factors	70/50/20
UGR C0/C180	11.4
UGR C90/C270	22.1
CIE Flux Codes	75 94 99 100 100
Ra/CRI	>80

LTS

StraitLine | Light-Module (Batwing/Wide Beam nanoOptix_bk, 1xLED 12W 840/4000K 1170lm)

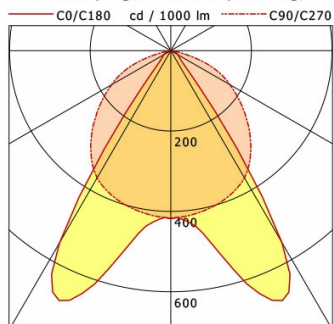

	C0	C90	C180	C270
0°	418	418	418	418
15°	547	402	547	402
30°	552	366	552	366
45°	40	275	40	275
60°	20	169	20	169
75°	7	46	7	46
90°	0	0	0	0
cd / 1000 lm				

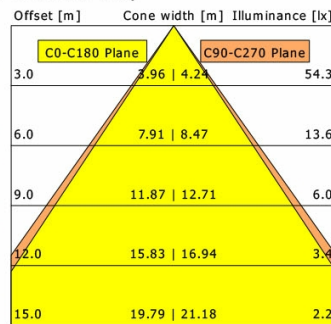

η	LED
Efficiency	98 lm/W
Direct/Indirect	↓ 100% / ↑ 0%
System Power	12 W
UGR	X=4H, Y=8H
Reflection factors	70/50/20
UGR C0/C180	14.1
UGR C90/C270	22.3
CIE Flux Codes	71 94 99 100 100
Ra/CRI	>80

LTS

STRL 607.0845.840/DALI

Zubehör



STRL-LK-Z070-060.102.00
Verbinder-Set linear



STRL-LK060-Z690.BW-WB.03
Lichtlenkungsfolie nanoOptix "Batwing und breitstrahlend"
(Länge: 3 m)



STRL-LK060-Z690.BW-WB.05
Lichtlenkungsfolie nanoOptix "Batwing und breitstrahlend"
(Länge: 5 m)



STRL-LK060-Z690.BW-WB.10
Lichtlenkungsfolie nanoOptix "Batwing und breitstrahlend"
(Länge: 10 m)



STRL-LK060-Z690.BW-WB.15
Lichtlenkungsfolie nanoOptix "Batwing und breitstrahlend"
(Länge: 15 m)



STRL-LK060-Z690.BW-WB.20
Lichtlenkungsfolie nanoOptix "Batwing und breitstrahlend"
(Länge: 20 m)



STRL-LK060-Z690.BW-WB.25
Lichtlenkungsfolie nanoOptix "Batwing und breitstrahlend"
(Länge: 25 m)



STRL-LK060-Z690.BW-WB.30
Lichtlenkungsfolie nanoOptix "Batwing und breitstrahlend"
(Länge: 30 m)



STRL-LK060-Z690.DB.03
Lichtlenkungsfolie nanoOptix "tiefstrahlend"
(Länge: 3 m)



STRL-LK060-Z690.DB.05
Lichtlenkungsfolie nanoOptix "tiefstrahlend"
(Länge: 5 m)



STRL-LK060-Z690.DB.10
Lichtlenkungsfolie nanoOptix "tiefstrahlend"
(Länge: 10 m)



STRL-LK060-Z690.DB.15
Lichtlenkungsfolie nanoOptix "tiefstrahlend"
(Länge: 15 m)



STRL-LK060-Z690.DB.20
Lichtlenkungsfolie nanoOptix "tiefstrahlend"
(Länge: 20 m)



STRL-LK060-Z690.DB.25
Lichtlenkungsfolie nanoOptix "tiefstrahlend"
(Länge: 25 m)



STRL-LK060-Z690.DB.30
Lichtlenkungsfolie nanoOptix "tiefstrahlend"
(Länge: 30 m)



STRL-LK060-Z690.OPDF.03
Lichtlenkungsfolie "opal diffus"
(Länge: 3 m)



STRL-LK060-Z690.OPDF.05
Lichtlenkungsfolie "opal diffus"
(Länge: 5 m)



STRL-LK060-Z690.OPDF.10
Lichtlenkungsfolie "opal diffus"
(Länge: 10 m)

STRL 607.0845.840/DALI

Zubehör



STRL-LK060-Z 690.OPDF.15
Lichtlenkungsfolie "opal diffus"
(Länge: 15 m)



STRL-LK060-Z 690.OPDF.20
Lichtlenkungsfolie "opal diffus"
(Länge: 20 m)



STRL-LK060-Z 690.OPDF.25
Lichtlenkungsfolie "opal diffus"
(Länge: 25 m)



STRL-LK060-Z 690.OPDF.30
Lichtlenkungsfolie "opal diffus"
(Länge: 30 m)



STRL-LKDI-Z 060.001
Enddeckel
(2 Stück)

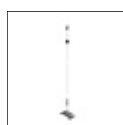

STRL-LKDI-Z 060.104.03
Drahtseil-Set ohne Einspeisung
(Länge: 3000 mm)



STRL-Z 100.05/DIM
Einspeise-Set
(Kabel 5-adrig, Länge: 5000 mm)

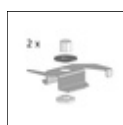

STRL-Z 104
Anbauklammern
(2 Stück)



STRL-Z 115
Linearverbinder für Deckenmontage
(1 Stück)



ZB-OR DONGLE
Organic Response IR-Dongle-Set



ZB-OR GATEWAY
Organic Response IoT-Gateway Kaskadenserie



ZB-OR-A SENSOR
Organic Response Sensor für Anbaumontage



ZB-OR-P SENSOR/3000
Organic Response Sensor für Pendelmontage