

ML-P 060.10840.3 OPD/DALI

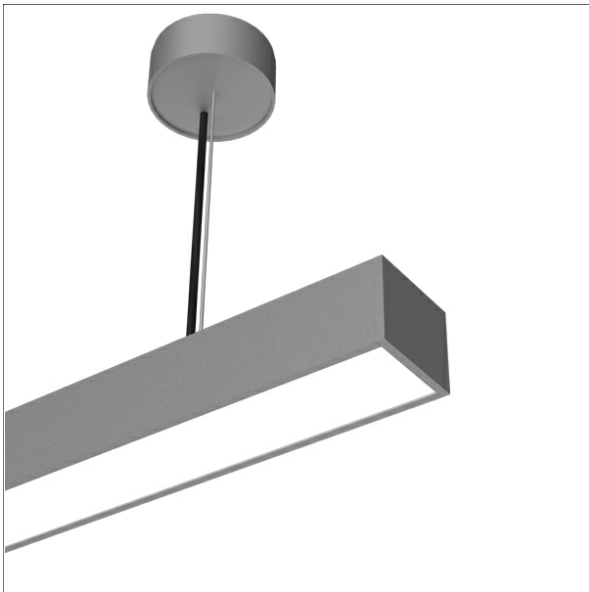

Beschreibung

- filigrane Linearleuchte für Pendelmontage
- symmetrische Lichtverteilung und gleichmäßig flächige Ausleuchtung
- hohe Wartungsfreundlichkeit
- keine UV- und Wärmestrahlung
- Gehäuse aus Aluminium
- Enddeckel aus Polycarbonat
- Lichtlenkungsfolie "opal diffus" mit Streuadditiv aus Polycarbonat
- höhenverstellbare Drahtseilabhängung 2-fach (Länge: 3000 mm)
- Betriebsgerät (LED-Konverter DALI, dimmbar) integriert

Hinweise

ACHTUNG: Die thermische Längenausdehnung des Aluminiumprofils beträgt bei $dT = 10$ Kelvin 0.3 mm pro Meter.

Standardoptionen



Sonderoptionen



Farbe	Artikelnummer	EAN
silber eloxiert	670585	4043544822529
schwarz	670586	4043544822536
weiß	670587	4043544822543

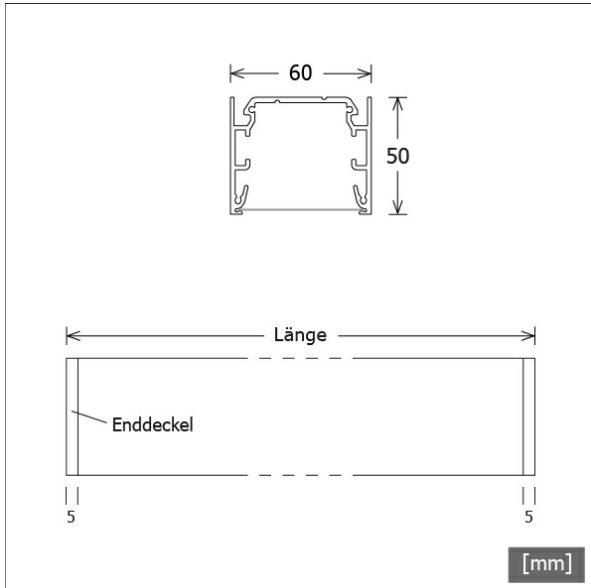

Lichttechnik / Normen

Leuchtmittel	LED linear / CRI 80 / 4000 K
Lebensdauer	L90 B50 50.000 h L80 B50 100.000 h L80 B20 50.000 h
Systemleistung	20.7 W
Leuchten-Lichtstrom	3330 lm
Systemeffizienz	160.86 lm/W
Moduleffizienz	205.00 lm/W
UGR Klasse	≤25
Versorgungsspannung	220 - 240 V / 50 - 60 Hz
Schutzklasse	I
Schutzart	IP20

Abmessungen / Gewichte

Länge	1420 mm
Breite	60 mm
Höhe	50 mm
Nettogewicht	3.92 kg
Bruttogewicht	4.44 kg

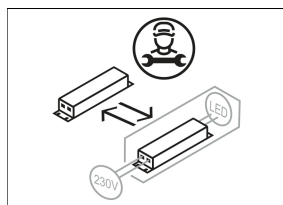
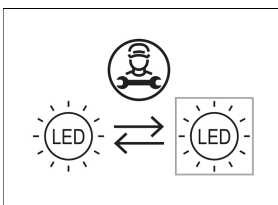

ML-P 060.10840.3 OPD/DALI

ML-P 060.10840.3 OPD/DALI

Monoline 060 | Pendant (1xLED 21W 840/4000K 3330lm)

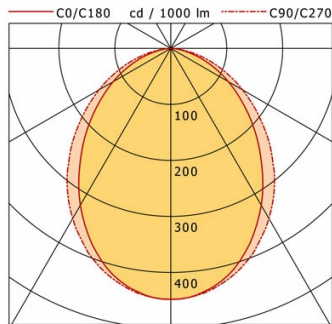

	C0	C90	C180	C270
0°	448	448	448	448
15°	414	422	414	422
30°	323	351	323	351
45°	214	253	214	253
60°	119	148	119	148
75°	42	58	42	58
90°	0	0	0	0

cd / 1000 lm

Offset [m]	Cone width [m]		Illuminance [lx]
3.0	5.72	6.90	165.8
6.0	11.45	13.79	41.4
9.0	17.17	20.69	18.4
12.0	22.89	27.58	10.4
15.0	28.62	34.48	6.6

η	LED
Efficiency	159 lm/W
Direct/Indirect	↓ 100% / ↑ 0%
System Power	21 W
UGR	X=4H, Y=8H
Reflection factors	70/50/20
UGR C0/C180	23.7
UGR C90/C270	24.9
CIE Flux Codes	54 84 97 100 100
Ra/CRI	>80

LTS

Zubehör



ZB-OR DONGLE
Organic Response IR-Dongle-Set



ZB-OR GATEWAY
Organic Response IoT-Gateway Kaskadenserie



ZB-OR-A SENSOR
Organic Response Sensor für Anbaumontage



ZB-OR-P SENSOR/3000
Organic Response Sensor für Pendelmontage