

# FLIR 200.2027.50

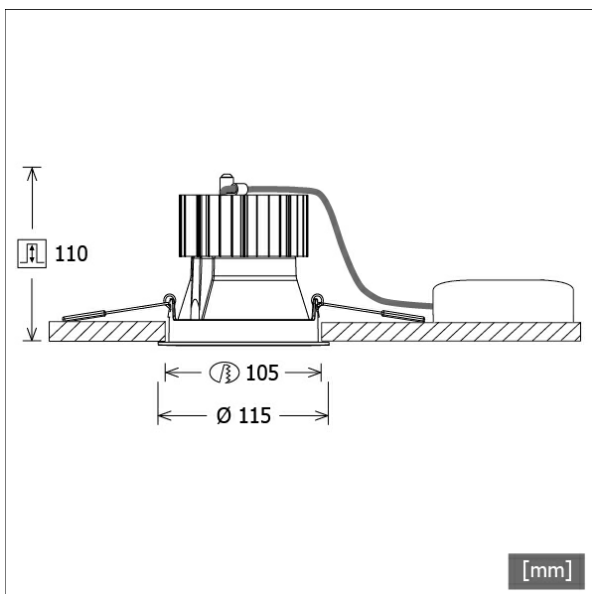

| Farbe   | Artikelnummer | EAN           |
|---------|---------------|---------------|
| schwarz | 636613        | 4043544391957 |
| silber  | 636614        | 4043544391964 |
| weiß    | 636615        | 4043544391971 |



## Beschreibung

- Einbaustrahler mit optischen Designvarianten und breitem Anwendungsspektrum
- Lichtkopf 20° schwenkbar
- hohe Wartungsfreundlichkeit
- keine UV- und Wärmestrahlung
- Wärmemanagement mit Passivkühlung (Kühlkörper aus Aluminium)
- High-Performance Spiegelreflektor aus Aluminium mit präziser symmetrischer Abstrahlcharakteristik für maximale Lichtausbeute und optimale Entblendung
- Front-/Einbauring aus Zinkdruckguss mit Lichteffektring klar (weitere Dekor-/Lichteffektringe und Dekogläser sind als Option erhältlich)
- werkzeugloser Deckeneinbau mit Schnellspannfedern (automatische Anpassung der Deckenstärke)
- Leuchte und Betriebsgerät über Kabel (Länge: 500 mm) fest verbunden, Betriebsgerät fertig für Netzanschluss
- Betriebsgerät (LED-Konverter) inklusive (Platzierung extern)

## Standardoptionen



## Sonderoptionen



## Lichttechnik / Normen

|                     |   |
|---------------------|---|
| Leuchtmittel        | LED Spot / CRI 80 / 2700 K                                |
| EPREL Lichtquellen  | 848120  |
| Lebensdauer         | L90 B50 50.000 h<br>L80 B50 100.000 h<br>L80 B20 50.000 h |
| Systemleistung      | 27,0 W  |
| Leuchten-Lichtstrom | max. 2740 lm  |
| Systemeffizienz     | 101,48 lm/W   |
| Moduleffizienz      | 127,18 lm/W   |
| UGR Klasse          | ≤28   |
| Abstrahlbereich     | Wide Flood  |
| Abstrahlwinkel      | 51°   |
| Versorgungsspannung | 220 - 240 V / 50 - 60 Hz                                  |
| Schutzklasse        | II  |
| Schutzart           | IP20  |

## Abmessungen / Gewichte

|                    |               |
|--------------------|---------------|
| Außendurchmesser   | 115 mm        |
| Höhe               | 112 mm        |
| Ausschnittsmaß (Ø) | 105 mm        |
| Deckenstärke       | 1,0 - 25,0 mm |
| Einbautiefe        | 110 mm        |
| Nettogewicht       | 0,87 kg       |
| Bruttogewicht      | 0,95 kg       |

# FLIR 200.2027.50

## FLIR 200.2027.50

Flixx 200 Round (FLIRZ 200.05, 1xLED 27W 827/2700K 2740lm 51°)

— C0/C180 cd / 1000 lm

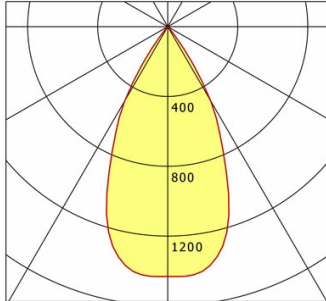

|              | C0   | C90  | C180 | C270 |
|--------------|------|------|------|------|
| 0°           | 1431 | 1431 | 1431 | 1431 |
| 15°          | 1264 | 1264 | 1264 | 1264 |
| 30°          | 492  | 492  | 492  | 492  |
| 45°          | 17   | 17   | 17   | 17   |
| 60°          | 14   | 14   | 14   | 14   |
| 75°          | 6    | 6    | 6    | 6    |
| 90°          | 0    | 0    | 0    | 0    |
| cd / 1000 lm |      |      |      |      |

Offset [m] Cone width [m] Illuminance [lx]

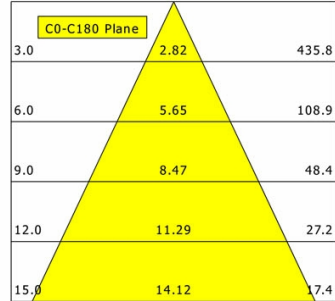

|                    |                   |
|--------------------|-------------------|
| <b>η</b>           | LED               |
| Efficiency         | 102 lm/W          |
| Direct/Indirect    | ↓ 100% / ↑ 0%     |
| System Power       | 27 W              |
| <b>UGR</b>         | X=4H, Y=8H        |
| Reflection factors | 70/50/20          |
| UGR C0/C180        | 21.2              |
| UGR C90/C270       | 21.2              |
| CIE Flux Codes     | 95 98 100 100 100 |
| Ra/CRI             | >80               |

LTS

## FLIR 200.2027.50

Flixx 200 Round (FLIRZ 200.25, 1xLED 27W 827/2700K 2660lm 51°)

— C0/C180 cd / 1000 lm

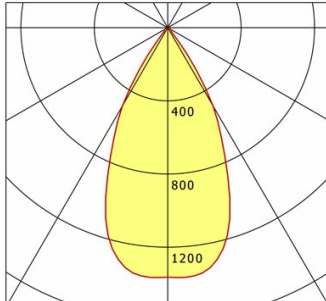

|              | C0   | C90  | C180 | C270 |
|--------------|------|------|------|------|
| 0°           | 1364 | 1364 | 1364 | 1364 |
| 15°          | 1216 | 1216 | 1216 | 1216 |
| 30°          | 494  | 494  | 494  | 494  |
| 45°          | 27   | 27   | 27   | 27   |
| 60°          | 17   | 17   | 17   | 17   |
| 75°          | 6    | 6    | 6    | 6    |
| 90°          | 0    | 0    | 0    | 0    |
| cd / 1000 lm |      |      |      |      |

Offset [m] Cone width [m] Illuminance [lx]

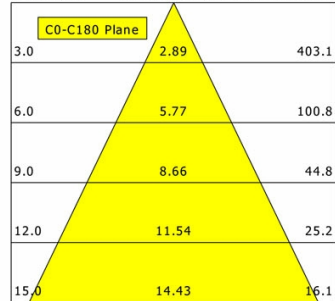

|                    |                   |
|--------------------|-------------------|
| <b>η</b>           | LED               |
| Efficiency         | 99 lm/W           |
| Direct/Indirect    | ↓ 100% / ↑ 0%     |
| System Power       | 27 W              |
| <b>UGR</b>         | X=4H, Y=8H        |
| Reflection factors | 70/50/20          |
| UGR C0/C180        | 21.5              |
| UGR C90/C270       | 21.5              |
| CIE Flux Codes     | 94 98 100 100 100 |
| Ra/CRI             | >80               |

LTS

## FLIR 200.2027.50

Flixx 200 Round (FLIRZ 200.24, 1xLED 27W 827/2700K 2580lm 51°)

— C0/C180 cd / 1000 lm

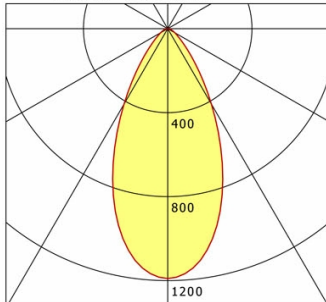

|              | C0   | C90  | C180 | C270 |
|--------------|------|------|------|------|
| 0°           | 1190 | 1190 | 1190 | 1190 |
| 15°          | 936  | 936  | 936  | 936  |
| 30°          | 415  | 415  | 415  | 415  |
| 45°          | 116  | 116  | 116  | 116  |
| 60°          | 39   | 39   | 39   | 39   |
| 75°          | 16   | 16   | 16   | 16   |
| 90°          | 0    | 0    | 0    | 0    |
| cd / 1000 lm |      |      |      |      |

Offset [m] Cone width [m] Illuminance [lx]

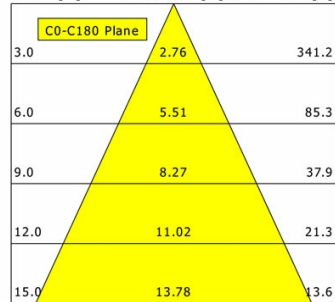

|                    |                  |
|--------------------|------------------|
| <b>η</b>           | LED              |
| Efficiency         | 96 lm/W          |
| Direct/Indirect    | ↓ 100% / ↑ 0%    |
| System Power       | 27 W             |
| <b>UGR</b>         | X=4H, Y=8H       |
| Reflection factors | 70/50/20         |
| UGR C0/C180        | 26.2             |
| UGR C90/C270       | 26.2             |
| CIE Flux Codes     | 83 95 99 100 100 |
| Ra/CRI             | >80              |

LTS

# FLIR 200.2027.50

## Zubehör



**FLIRZ 200.01**  
Dekorring schwarz



**FLIRZ 200.02**  
Dekorring silber



**FLIRZ 200.03**  
Dekorring weiß



**FLIRZ 200.04**  
Lichteffektring opal



**FLIRZ 200.05**  
Lichteffektring klar



**FLIRZ 200.06**  
Lichteffektring rot matt



**FLIRZ 200.07**  
Lichteffektring gelb matt



**FLIRZ 200.08**  
Lichteffektring blau matt



**FLIRZ 200.16**  
Lichteffektring rot transluzent



**FLIRZ 200.17**  
Lichteffektring gelb transluzent



**FLIRZ 200.18**  
Lichteffektring blau transluzent

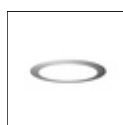

**FLIRZ 200.24**  
Dekoglas opal



**FLIRZ 200.25**  
Dekoglas klar