

FLIQ 300.1040.01

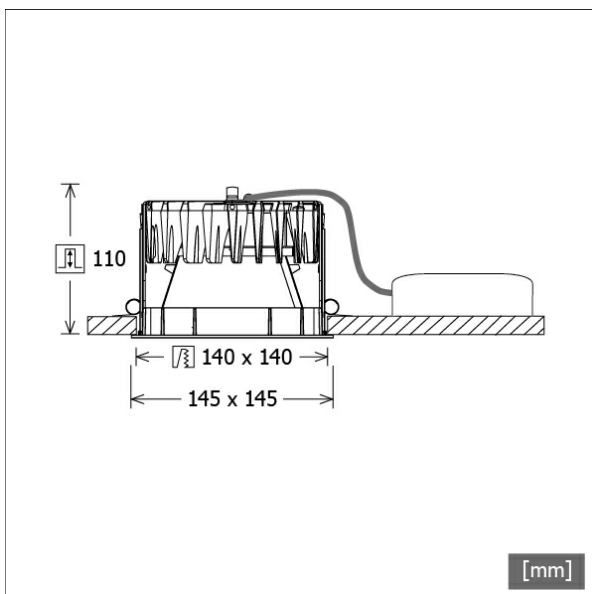

Farbe	Artikelnummer	EAN
schwarz	636438	4043544390189
silber	636439	4043544390196
weiß	636440	4043544390202



Beschreibung

- Einbau-Downlight mit optischen Designvarianten für Allgemeinbeleuchtung
- hohe Wartungsfreundlichkeit
- keine UV- und Wärmestrahlung
- innovatives Wärmemanagement mit Passivkühlung (Kühlkörper aus Aluminiumdruckguss)
- entspiegelter Mattreflektor aus Aluminium für maximale Lichtausbeute und optimale Entblendung
- Front-/Einbaurahmen aus Zinkdruckguss mit Lichteffektrahmen klar (weitere Dekor-/Lichteffektrahmen und Dekogläser sind als Option erhältlich)
- werkzeugloser Deckeneinbau mit Schnellspannautomatik (automatische Anpassung der Deckenstärke)
- Leuchte und Betriebsgerät über Kabel (Länge: 500 mm) fest verbunden, Betriebsgerät fertig für Netzanschluss
- Betriebsgerät (LED-Konverter) inklusive (Platzierung extern)

Standardoptionen



Sonderoptionen



Lichttechnik / Normen

Leuchtmittel	LED Modul / CRI 80 / 4000 K
EPREL Lichtquellen	891010
Lebensdauer	L90 B50 50.000 h L80 B50 100.000 h L80 B20 50.000 h
Systemleistung	11.0 W
Leuchten-Lichtstrom	max. 1060 lm
Systemeffizienz	96.36 lm/W
Moduleffizienz	173.48 lm/W
UGR Klasse	≤22
Versorgungsspannung	220 - 240 V / 50 - 60 Hz
Schutzklasse	II
Schutzart	IP20

Abmessungen / Gewichte

Länge	145 mm
Breite	145 mm
Höhe	112 mm
Ausschnittsmaß (LxB))	140 x 140 mm
Deckenstärke	5.0 - 50.0 mm
Einbautiefe	110 mm
Nettogewicht	1.00 kg
Bruttogewicht	1.06 kg

FLIQ 300.1040.01

Flixx 300 Square (FLIQZ 300.05, 1xLED 11W 840/4000K 1060lm)

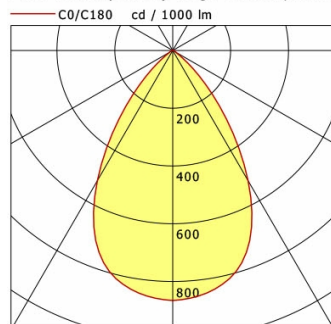

	C0	C90	C180	C270
0°	866	866	866	866
15°	805	805	805	805
30°	521	521	521	521
45°	145	145	145	145
60°	13	13	13	13
75°	6	6	6	6
90°	0	0	0	0

cd / 1000 lm

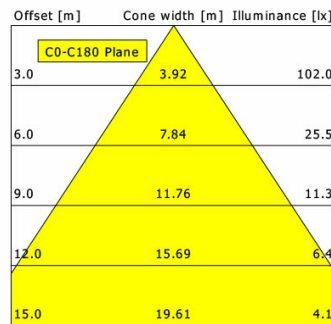

η	LED
Efficiency	96 lm/W
Direct/Indirect	↓ 100% / ↑ 0%
System Power	11 W
UGR	X=4H, Y=8H
Reflection factors	70/50/20
UGR C0/C180	18.0
UGR C90/C270	18.0
CIE Flux Codes	86 98 99 100 100
Ra/CRI	>80

LTS

Flixx 300 Square (FLIQZ 300.24, 1xLED 11W 840/4000K 1030lm)

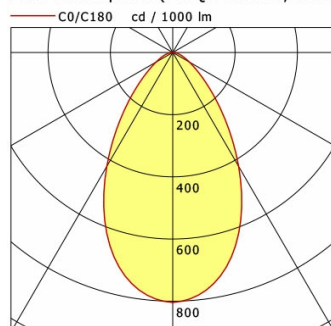

	C0	C90	C180	C270
0°	804	804	804	804
15°	698	698	698	698
30°	423	423	423	423
45°	173	173	173	173
60°	62	62	62	62
75°	22	22	22	22
90°	0	0	0	0

cd / 1000 lm

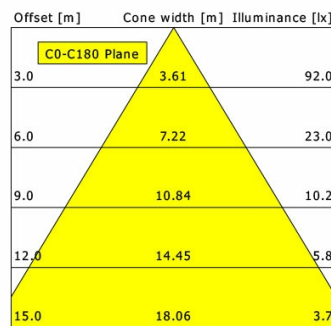

η	LED
Efficiency	94 lm/W
Direct/Indirect	↓ 100% / ↑ 0%
System Power	11 W
UGR	X=4H, Y=8H
Reflection factors	70/50/20
UGR C0/C180	21.8
UGR C90/C270	21.8
CIE Flux Codes	73 93 98 100 100
Ra/CRI	>80

LTS

Flixx 300 Square (FLIQZ 300.25, 1xLED 11W 840/4000K 1050lm)

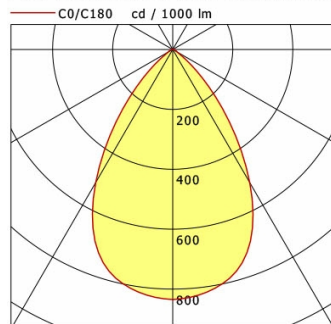

	C0	C90	C180	C270
0°	835	835	835	835
15°	779	779	779	779
30°	513	513	513	513
45°	155	155	155	155
60°	18	18	18	18
75°	6	6	6	6
90°	0	0	0	0

cd / 1000 lm

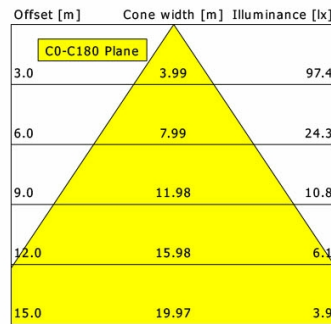

η	LED
Efficiency	95 lm/W
Direct/Indirect	↓ 100% / ↑ 0%
System Power	11 W
UGR	X=4H, Y=8H
Reflection factors	70/50/20
UGR C0/C180	18.3
UGR C90/C270	18.3
CIE Flux Codes	85 98 100 100 100
Ra/CRI	>80

LTS

FLIQ 300.1040.01

Zubehör



FLIQ 300.01
Dekorrahmen schwarz



FLIQ 300.02
Dekorrahmen silber



FLIQ 300.03
Dekorrahmen weiß



FLIQ 300.04
Lichteffektrahmen opal



FLIQ 300.05
Lichteffektrahmen klar



FLIQ 300.06
Lichteffektrahmen rot matt



FLIQ 300.07
Lichteffektrahmen gelb matt



FLIQ 300.08
Lichteffektrahmen blau matt



FLIQ 300.16
Lichteffektrahmen rot transluzent



FLIQ 300.17
Lichteffektrahmen gelb transluzent



FLIQ 300.18
Lichteffektrahmen blau transluzent



FLIQ 300.24
Dekoglas opal



FLIQ 300.25
Dekoglas klar



NOL 50B/3H/DALI
LED-Notlichteinheit



ZVP 100
Universalverstärkungsrahmen
(Modul 625 x 625)