

# STRL 610.1125.840/DALI

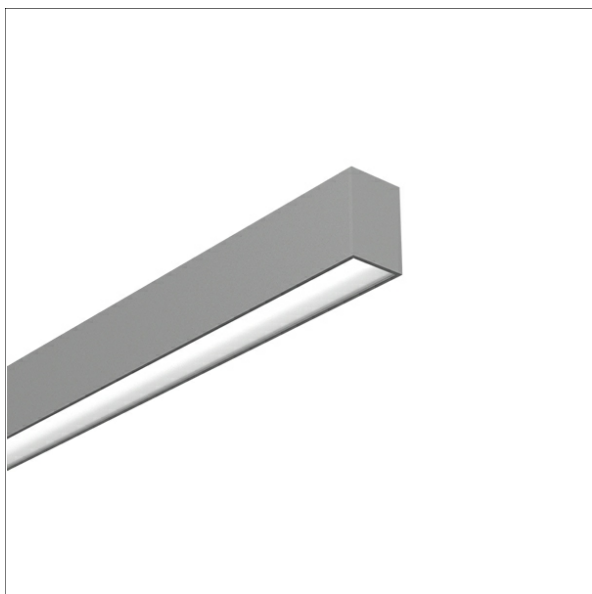

Farbe	Artikelnummer	EAN
silber eloxiert	667757	4043544771049
schwarz	667758	4043544771056
weiß	667759	4043544771063

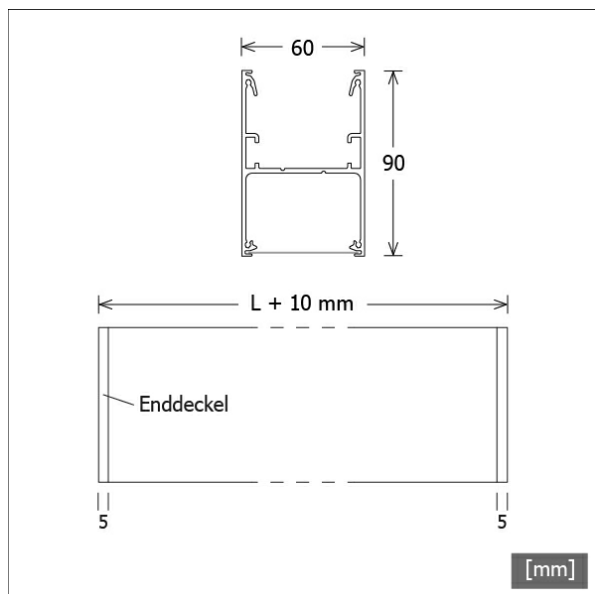

## Beschreibung

- Lichtbandsystem für Decken- oder Pendelmontage
- Lichtmodule in verschiedenen Fixlängen zur Realisierung von variablen Lichtlinien (auch für sehr große Längen geeignet)
- hohe Wartungsfreundlichkeit
- keine UV- und Wärmestrahlung
- Modulgehäuse aus hochwertig extrudiertem Aluminiumprofil
- integriertes LED-Lichtband mit gewölbtem PMMA-Diffusor für homogene Lichtverteilung Lichtlenkung durch hocheffiziente nanoOptix-Folien von LTS mit Mikrolinsenstruktur und verschiedene Abstrahlcharakteristiken (Batwing/breitstrahlend, tiefstrahlend) oder über Standardfolie "opal diffus", LTS-nanoOptix-Folien sind optional erhältlich bis 150 m Länge (Vorteile: keine Stoßkanten, durchgängiges homogenes Lichtbild über die ganze Folienlänge)
- Enddeckel, Lichtlenkungsfolien und erforderliche Systemkomponenten separat bestellen
- Modul ohne Lichtlenkungsfolien
- Montage über Anbauklammern oder Drahtseilabhängung
- steckerfertig für Durchgangsverdrahtung
- Betriebsgerät (LED-Konverter DALI, dimmbar) integriert

## Hinweise

Die thermische Längenausdehnung des Aluminiumprofils beträgt bei  $\Delta T = 10$  Kelvin 0.3 mm pro Meter.

## Standardoptionen



## Sonderoptionen



## Lichttechnik / Normen

Leuchtmittel	LED linear / CRI 80 / 4000 K
EPREL Lichtquellen	833900
Lebensdauer	L90 B50 50.000 h L80 B50 100.000 h L80 B20 50.000 h
Systemleistung	29.6 W
Leuchten-Lichtstrom	max. 3520 lm
Systemeffizienz	105.06 lm/W
Moduleffizienz	188.50 lm/W
UGR Klasse	≤28
Versorgungsspannung	220 - 240 V / 50 - 60 Hz
Schutzklasse	I
Schutzart	IP20

## Abmessungen / Gewichte

Länge	1125 mm
Breite	60 mm
Höhe	90 mm
Nettogewicht	3.15 kg
Bruttogewicht	3.34 kg

# STRL 610.1125.840/DALI

StraitLine | Light-Module (Opal Diffuse\_si\_wh, 1xLED 30W 840/4000K 3110lm)

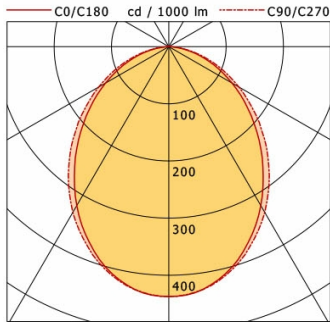

	C0	C90	C180	C270
0°	437	437	437	437
15°	405	409	405	409
30°	321	335	321	335
45°	220	239	220	239
60°	128	141	128	141
75°	51	57	51	57
90°	0	0	0	0
cd / 1000 lm				

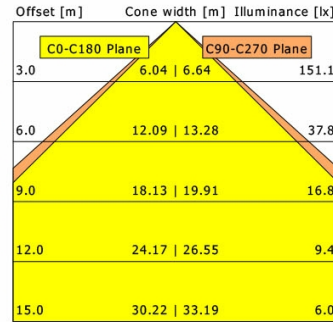

<b>η</b>	LED
Efficiency	104 lm/W
Direct/Indirect	↓ 100% / ↑ 0%
System Power	30 W
<b>UGR</b>	X=4H, Y=8H
Reflection factors	70/50/20
UGR C0/C180	25.0
UGR C90/C270	25.5
CIE Flux Codes	53 83 97 100 100
Ra/CRI	>80

LTS

StraitLine | Light-Module (Deep Beam nanoOptix\_si\_wh, 1xLED 30W 840/4000K 3240lm)

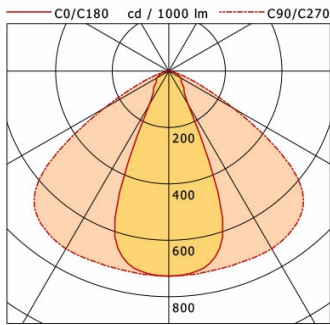

	C0	C90	C180	C270
0°	727	727	727	727
15°	667	724	667	724
30°	138	728	138	728
45°	69	673	69	673
60°	49	267	49	267
75°	23	33	23	33
90°	0	0	0	0
cd / 1000 lm				

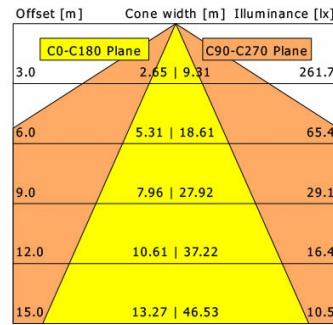

<b>η</b>	LED
Efficiency	108 lm/W
Direct/Indirect	↓ 100% / ↑ 0%
System Power	30 W
<b>UGR</b>	X=4H, Y=8H
Reflection factors	70/50/20
UGR C0/C180	19.0
UGR C90/C270	24.7
CIE Flux Codes	71 92 99 100 100
Ra/CRI	>80

LTS

StraitLine | Light-Module (Batwing/Wide Beam nanoOptix\_si\_wh, 1xLED 30W 840/4000K 3520lm)

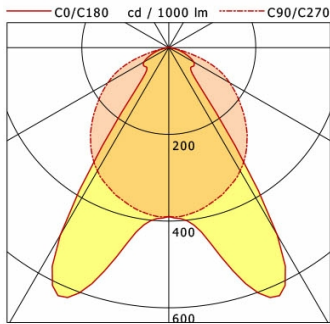

	C0	C90	C180	C270
0°	390	390	390	390
15°	516	372	516	372
30°	499	328	499	328
45°	71	251	71	251
60°	66	161	66	161
75°	25	46	25	46
90°	0	0	0	0
cd / 1000 lm				

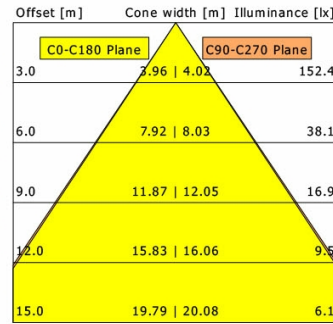

<b>η</b>	LED
Efficiency	117 lm/W
Direct/Indirect	↓ 100% / ↑ 0%
System Power	30 W
<b>UGR</b>	X=4H, Y=8H
Reflection factors	70/50/20
UGR C0/C180	20.9
UGR C90/C270	24.9
CIE Flux Codes	66 90 99 100 100
Ra/CRI	>80

LTS

StraitLine | Light-Module (Opal Diffuse\_bk, 1xLED 30W 840/4000K 2600lm)

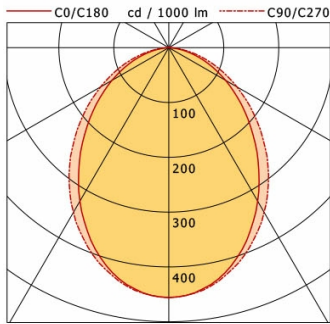

	C0	C90	C180	C270
0°	456	456	456	456
15°	418	424	418	424
30°	323	347	323	347
45°	213	245	213	245
60°	119	143	119	143
75°	45	57	45	57
90°	0	0	0	0
cd / 1000 lm				

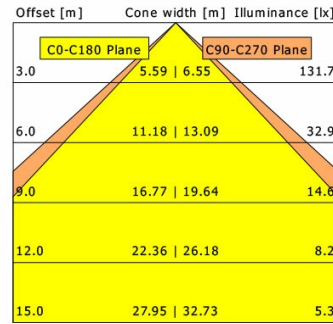

<b>η</b>	LED
Efficiency	87 lm/W
Direct/Indirect	↓ 100% / ↑ 0%
System Power	30 W
<b>UGR</b>	X=4H, Y=8H
Reflection factors	70/50/20
UGR C0/C180	23.8
UGR C90/C270	24.8
CIE Flux Codes	54 83 97 100 100
Ra/CRI	>80

LTS

# STRL 610.1125.840/DALI

StraitLine | Light-Module (Deep Beam nanoOptix\_bk, 1xLED 30W 840/4000K 2780lm)

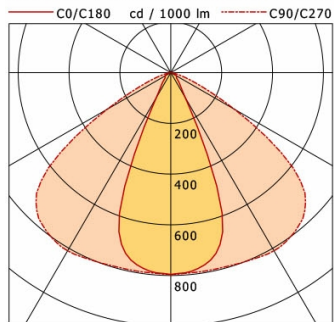

	C0	C90	C180	C270
0°	796	796	796	796
15°	721	795	721	795
30°	114	811	114	811
45°	35	748	35	748
60°	26	290	26	290
75°	10	33	10	33
90°	0	0	0	0

cd / 1000 lm

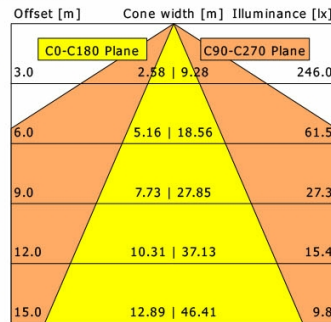

<b>η</b>	LED
Efficiency	93 lm/W
Direct/Indirect	↓ 100% / ↑ 0%
System Power	30 W
<b>UGR</b>	X=4H, Y=8H
Reflection factors	70/50/20
UGR C0/C180	13.8
UGR C90/C270	24.4
CIE Flux Codes	75 94 99 100 100
Ra/CRI	>80

LTS

StraitLine | Light-Module (Batwing/Wide Beam nanoOptix\_bk, 1xLED 30W 840/4000K 3040lm)

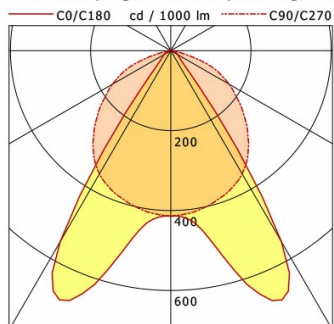

	C0	C90	C180	C270
0°	414	414	414	414
15°	548	396	548	396
30°	552	356	552	356
45°	41	269	41	269
60°	20	168	20	168
75°	8	46	8	46
90°	0	0	0	0

cd / 1000 lm

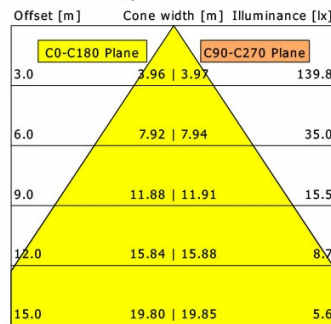

<b>η</b>	LED
Efficiency	101 lm/W
Direct/Indirect	↓ 100% / ↑ 0%
System Power	30 W
<b>UGR</b>	X=4H, Y=8H
Reflection factors	70/50/20
UGR C0/C180	16.5
UGR C90/C270	24.6
CIE Flux Codes	71 94 99 100 100
Ra/CRI	>80

LTS

# STRL 610.1125.840/DALI

## Zubehör



**STRL-LK-Z 070-060.102.00**  
Verbinder-Set linear



**STRL-LK060-Z 690.BW-WB.03**  
Lichtlenkungsfolie nanoOptix "Batwing und breitstrahlend"  
(Länge: 3 m)



**STRL-LK060-Z 690.BW-WB.05**  
Lichtlenkungsfolie nanoOptix "Batwing und breitstrahlend"  
(Länge: 5 m)



**STRL-LK060-Z 690.BW-WB.10**  
Lichtlenkungsfolie nanoOptix "Batwing und breitstrahlend"  
(Länge: 10 m)



**STRL-LK060-Z 690.BW-WB.15**  
Lichtlenkungsfolie nanoOptix "Batwing und breitstrahlend"  
(Länge: 15 m)



**STRL-LK060-Z 690.BW-WB.20**  
Lichtlenkungsfolie nanoOptix "Batwing und breitstrahlend"  
(Länge: 20 m)



**STRL-LK060-Z 690.BW-WB.25**  
Lichtlenkungsfolie nanoOptix "Batwing und breitstrahlend"  
(Länge: 25 m)



**STRL-LK060-Z 690.BW-WB.30**  
Lichtlenkungsfolie nanoOptix "Batwing und breitstrahlend"  
(Länge: 30 m)



**STRL-LK060-Z 690.DB.03**  
Lichtlenkungsfolie nanoOptix "tiefstrahlend"  
(Länge: 3 m)



**STRL-LK060-Z 690.DB.05**  
Lichtlenkungsfolie nanoOptix "tiefstrahlend"  
(Länge: 5 m)



**STRL-LK060-Z 690.DB.10**  
Lichtlenkungsfolie nanoOptix "tiefstrahlend"  
(Länge: 10 m)



**STRL-LK060-Z 690.DB.15**  
Lichtlenkungsfolie nanoOptix "tiefstrahlend"  
(Länge: 15 m)



**STRL-LK060-Z 690.DB.20**  
Lichtlenkungsfolie nanoOptix "tiefstrahlend"  
(Länge: 20 m)



**STRL-LK060-Z 690.DB.25**  
Lichtlenkungsfolie nanoOptix "tiefstrahlend"  
(Länge: 25 m)



**STRL-LK060-Z 690.DB.30**  
Lichtlenkungsfolie nanoOptix "tiefstrahlend"  
(Länge: 30 m)



**STRL-LK060-Z 690.OPDF.03**  
Lichtlenkungsfolie "opal diffus"  
(Länge: 3 m)



**STRL-LK060-Z 690.OPDF.05**  
Lichtlenkungsfolie "opal diffus"  
(Länge: 5 m)



**STRL-LK060-Z 690.OPDF.10**  
Lichtlenkungsfolie "opal diffus"  
(Länge: 10 m)

# STRL 610.1125.840/DALI

## Zubehör



**STRL-LK060-Z 690.OPDF.15**  
Lichtlenkungsfolie "opal diffus"  
(Länge: 15 m)



**STRL-LK060-Z 690.OPDF.20**  
Lichtlenkungsfolie "opal diffus"  
(Länge: 20 m)



**STRL-LK060-Z 690.OPDF.25**  
Lichtlenkungsfolie "opal diffus"  
(Länge: 25 m)



**STRL-LK060-Z 690.OPDF.30**  
Lichtlenkungsfolie "opal diffus"  
(Länge: 30 m)

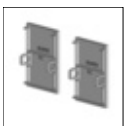

**STRL-LKDI-Z 060.001**  
Enddeckel  
(2 Stück)

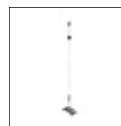

**STRL-LKDI-Z 060.104.03**  
Drahtseil-Set ohne Einspeisung  
(Länge: 3000 mm)



**STRL-Z 100.05/DIM**  
Einspeise-Set  
(Kabel 5-adrig, Länge: 5000 mm)

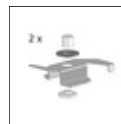

**STRL-Z 104**  
Anbauklammern  
(2 Stück)



**STRL-Z 115**  
Linearverbinder für Deckenmontage  
(1 Stück)



**ZB-OR DONGLE**  
Organic Response IR-Dongle-Set



**ZB-OR GATEWAY**  
Organic Response IoT-Gateway Kaskadenserie



**ZB-OR-A SENSOR**  
Organic Response Sensor für Anbaumontage



**ZB-OR-P SENSOR/3000**  
Organic Response Sensor für Pendelmontage