

FLIR-F 300.3040.01/DALI

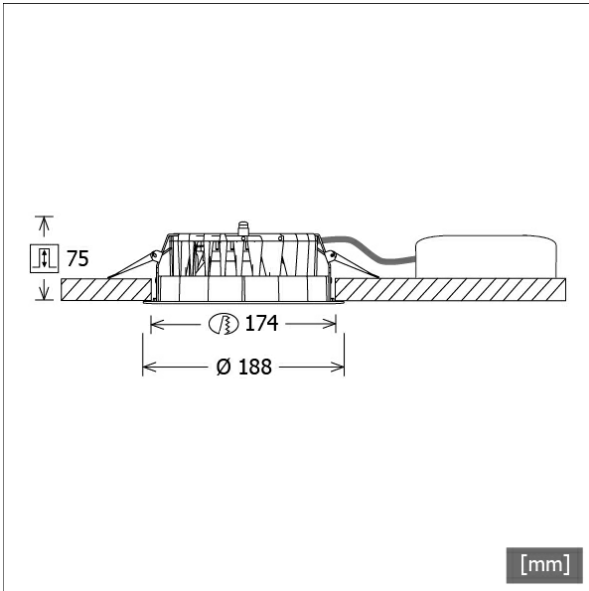

Farbe	Artikelnummer	EAN
schwarz	651640	4043544604101
silber	651641	4043544604118
weiß	651642	4043544604125



Beschreibung

- Einbau-Downlight mit optischen Designvarianten für Allgemeinbeleuchtung
- sehr geringe Einbautiefe
- hohe Wartungsfreundlichkeit
- keine UV- und Wärmestrahlung
- innovatives Wärmemanagement mit Passivkühlung (Kühlkörper aus Aluminiumdruckguss)
- High-Performance Spiegelreflektor aus Aluminium mit präziser symmetrischer Abstrahlcharakteristik für maximale Lichtausbeute und optimale Entblendung
- Front-/Einbauring aus Zinkdruckguss mit Lichteffektring klar (weitere Dekor-/Lichteffektringe und Dekogläser sind als Option erhältlich)
- werkzeugloser Deckeneinbau mit Schnellspannern (automatische Anpassung der Deckenstärke)
- Leuchte und Betriebsgerät über Kabel (Länge: 500 mm) fest verbunden, Betriebsgerät fertig für Netzanschluss
- Betriebsgerät (LED-Konverter DALI, dimmbar) inklusive (Platzierung extern)

Standardoptionen



Sonderoptionen



Lichttechnik / Normen

Leuchtmittel	LED Modul / CRI 80 / 4000 K
EPREL Lichtquellen	891020
Lebensdauer	L90 B50 50.000 h L80 B50 100.000 h L80 B20 50.000 h
Systemleistung	29,0 W
Leuchten-Lichtstrom	max. 3020 lm
Systemeffizienz	104,13 lm/W
Moduleffizienz	123,23 lm/W
UGR Klasse	≤28
Abstrahlwinkel	85°
Versorgungsspannung	220 - 240 V / 50 - 60 Hz
Schutzklasse	II
Schutzart	IP20

Abmessungen / Gewichte

Außendurchmesser	188 mm
Höhe	77 mm
Ausschnittsmaß (Ø)	174 mm
Deckenstärke	5,0 - 40,0 mm
Einbautiefe	75 mm
Nettogewicht	1,13 kg
Bruttogewicht	1,19 kg

FLIR-F 300.3040.01/DALI

Flixx 300 Flat Round (FLIRZ 300.05, 1xLED 29W 840/4000K 3020lm 85 °)

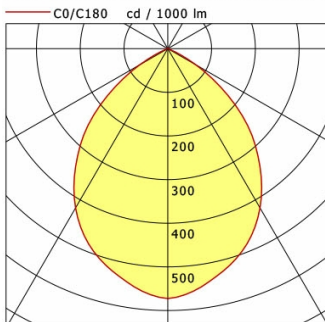

	C0	C90	C180	C270
0°	573	573	573	573
15°	520	520	520	520
30°	421	421	421	421
45°	266	266	266	266
60°	74	74	74	74
75°	1	1	1	1
90°	0	0	0	0

cd / 1000 lm

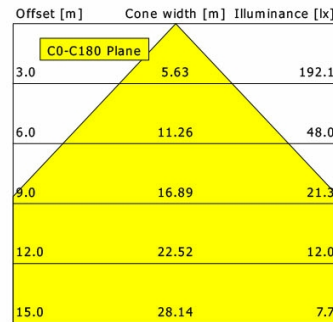

η	LED
Efficiency	104 lm/W
Direct/Indirect	↓ 100% / ↑ 0%
System Power	29 W
UGR	X=4H, Y=8H
Reflection factors	70/50/20
UGR C0/C180	25.0
UGR C90/C270	25.0
CIE Flux Codes	68 97 100 100 100
Ra/CRI	>80

LTS

Flixx 300 Flat Round (FLIRZ 300.24, 1xLED 29W 840/4000K 2830lm 85 °)

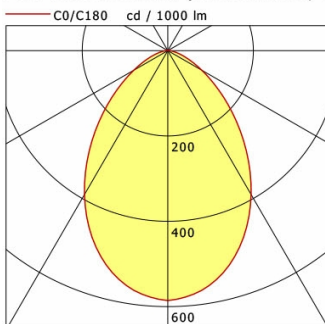

	C0	C90	C180	C270
0°	586	586	586	586
15°	530	530	530	530
30°	389	389	389	389
45°	221	221	221	221
60°	92	92	92	92
75°	27	27	27	27
90°	0	0	0	0

cd / 1000 lm

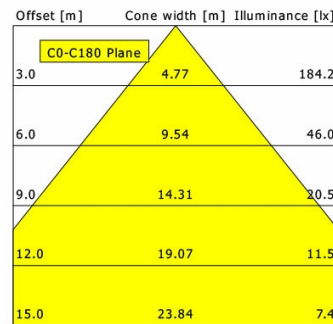

η	LED
Efficiency	98 lm/W
Direct/Indirect	↓ 100% / ↑ 0%
System Power	29 W
UGR	X=4H, Y=8H
Reflection factors	70/50/20
UGR C0/C180	26.4
UGR C90/C270	26.4
CIE Flux Codes	64 90 98 100 100
Ra/CRI	>80

LTS

Flixx 300 Flat Round (FLIRZ 300.25, 1xLED 29W 840/4000K 2940lm 85 °)

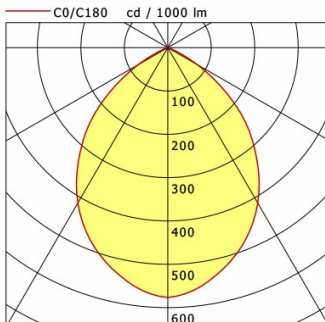

	C0	C90	C180	C270
0°	577	577	577	577
15°	521	521	521	521
30°	414	414	414	414
45°	261	261	261	261
60°	79	79	79	79
75°	4	4	4	4
90°	0	0	0	0

cd / 1000 lm

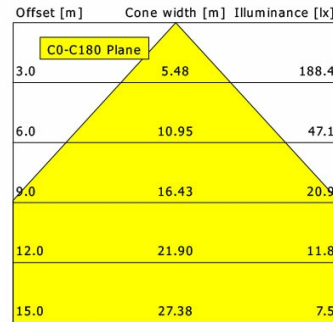

η	LED
Efficiency	101 lm/W
Direct/Indirect	↓ 100% / ↑ 0%
System Power	29 W
UGR	X=4H, Y=8H
Reflection factors	70/50/20
UGR C0/C180	25.0
UGR C90/C270	25.0
CIE Flux Codes	67 96 100 100 100
Ra/CRI	>80

LTS

FLIR-F 300.3040.01/DALI

Zubehör



FLIRZ 300.01
Dekoring schwarz



FLIRZ 300.02
Dekoring silber



FLIRZ 300.03
Dekoring weiß



FLIRZ 300.04
Lichteffektring opal



FLIRZ 300.05
Lichteffektring klar



FLIRZ 300.06
Lichteffektring rot matt



FLIRZ 300.07
Lichteffektring gelb matt



FLIRZ 300.08
Lichteffektring blau matt



FLIRZ 300.16
Lichteffektring rot transluzent



FLIRZ 300.17
Lichteffektring gelb transluzent



FLIRZ 300.18
Lichteffektring blau transluzent

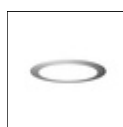

FLIRZ 300.24
Dekoglas opal



FLIRZ 300.25
Dekoglas klar



NOL 50B/3H/DALI
LED-Notlichteinheit



ZB-OR DONGLE
Organic Response IR-Dongle-Set



ZB-OR GATEWAY
Organic Response IoT-Gateway Kaskadenserie



ZB-OR-R SENSOR
Organic Response Sensor für Einbaumontage



ZDAR 175.215-275
Ausgleichsring für Deckenausschnitte von 215 – 275 mm

Einbau-Downlights · Flixx 300 Flat Round



FLIR-F 300.3040.01/DALI

Zubehör



ZVP 100
Universalverstärkungsrahmen
(Modul 625 x 625)