

FLIR 200.2027.35

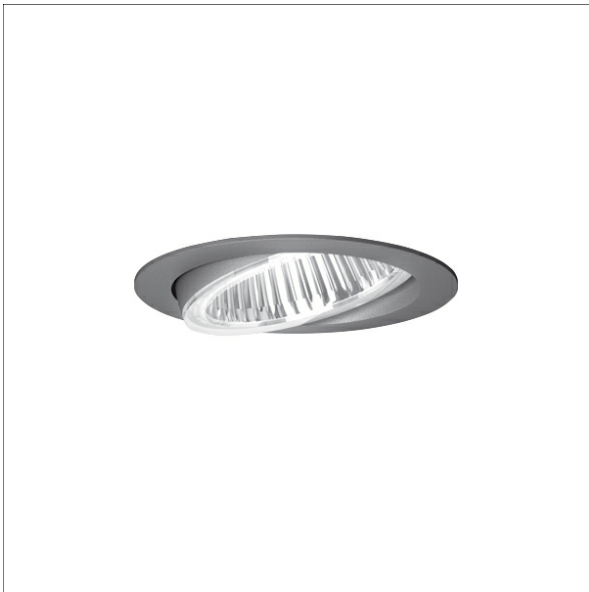

Farbe	Artikelnummer	EAN
schwarz	636604	4043544391865
silber	636605	4043544391872
weiß	636606	4043544391889

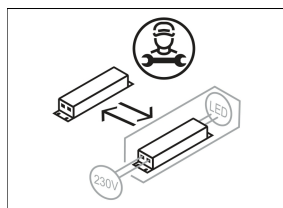
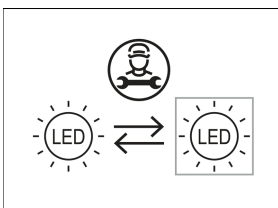
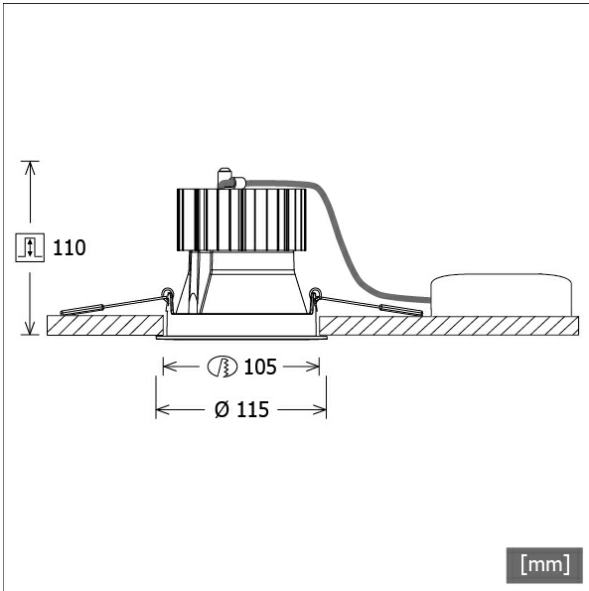

Beschreibung

- Einbaustrahler mit optischen Designvarianten und breitem Anwendungsspektrum
- Lichtkopf 20° schwenkbar
- hohe Wartungsfreundlichkeit
- keine UV- und Wärmestrahlung
- Wärmemanagement mit Passivkühlung (Kühlkörper aus Aluminium)
- High-Performance Spiegelreflektor aus Aluminium mit präziser symmetrischer Abstrahlcharakteristik für maximale Lichtausbeute und optimale Entblendung
- Front-/Einbauring aus Zinkdruckguss mit Lichteffektring klar (weitere Dekor-/Lichteffektringe und Dekogläser sind als Option erhältlich)
- werkzeugloser Deckeneinbau mit Schnellspannfedern (automatische Anpassung der Deckenstärke)
- Leuchte und Betriebsgerät über Kabel (Länge: 500 mm) fest verbunden, Betriebsgerät fertig für Netzanschluss
- Betriebsgerät (LED-Konverter) inklusive (Platzierung extern)

Standardoptionen



Sonderoptionen



Lichttechnik / Normen

Leuchtmittel	LED Spot / CRI 80 / 2700 K
EPREL Lichtquellen	848120
Lebensdauer	L90 B50 50.000 h L80 B50 100.000 h L80 B20 50.000 h
Systemleistung	27.0 W
Leuchten-Lichtstrom	max. 2810 lm
Systemeffizienz	104.07 lm/W
Moduleffizienz	127.18 lm/W
UGR Klasse	≤28
Abstrahlbereich	Flood
Abstrahlwinkel	36°
Versorgungsspannung	220 - 240 V / 50 - 60 Hz
Schutzklasse	II
Schutzart	IP20

Abmessungen / Gewichte

Außendurchmesser	115 mm
Höhe	112 mm
Ausschnittsmaß (Ø)	105 mm
Deckenstärke	1.0 - 25.0 mm
Einbautiefe	110 mm
Nettogewicht	0.87 kg
Bruttogewicht	0.95 kg

FLIR 200.2027.35

FLIR 200.2027.35

Flixx 200 Round (FLIRZ 200.05, 1xLED 27W 827/2700K 2810lm 36°)

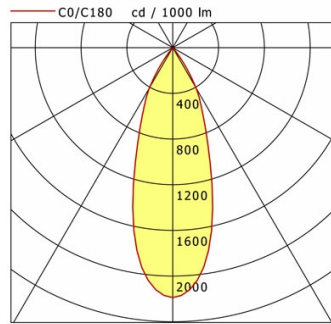

	C0	C90	C180	C270
0°	2188	2188	2188	2188
15°	1344	1344	1344	1344
30°	409	409	409	409
45°	18	18	18	18
60°	14	14	14	14
75°	6	6	6	6
90°	0	0	0	0

cd / 1000 lm

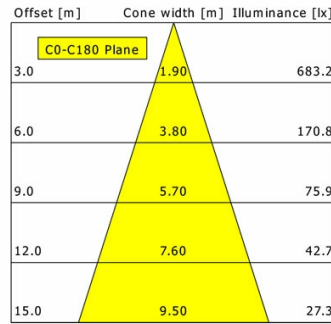

η	LED
Efficiency	104 lm/W
Direct/Indirect	↓ 100% / ↑ 0%
System Power	27 W
UGR	X=4H, Y=8H
Reflection factors	70/50/20
UGR C0/C180	20.4
UGR C90/C270	20.4
CIE Flux Codes	96 98 100 100 100
Ra/CRI	>80

LTS

FLIR 200.2027.35

Flixx 200 Round (FLIRZ 200.25, 1xLED 27W 827/2700K 2730lm 36°)

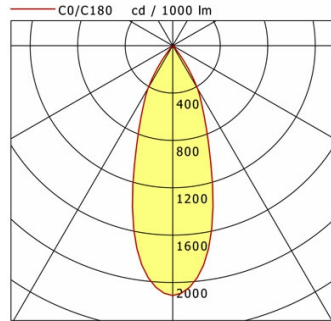

	C0	C90	C180	C270
0°	2110	2110	2110	2110
15°	1310	1310	1310	1310
30°	419	419	419	419
45°	21	21	21	21
60°	16	16	16	16
75°	5	5	5	5
90°	0	0	0	0

cd / 1000 lm

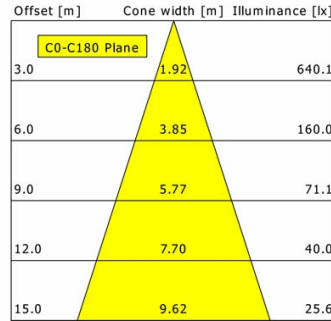

η	LED
Efficiency	101 lm/W
Direct/Indirect	↓ 100% / ↑ 0%
System Power	27 W
UGR	X=4H, Y=8H
Reflection factors	70/50/20
UGR C0/C180	20.6
UGR C90/C270	20.6
CIE Flux Codes	95 98 100 100 100
Ra/CRI	>80

LTS

FLIR 200.2027.35

Flixx 200 Round (FLIRZ 200.24, 1xLED 27W 827/2700K 2650lm 36°)

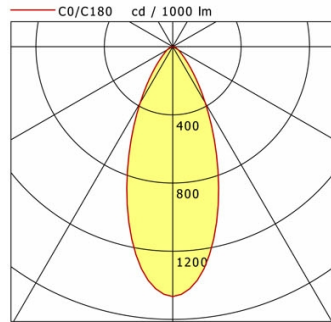

	C0	C90	C180	C270
0°	1466	1466	1466	1466
15°	1014	1014	1014	1014
30°	382	382	382	382
45°	104	104	104	104
60°	37	37	37	37
75°	15	15	15	15
90°	0	0	0	0

cd / 1000 lm

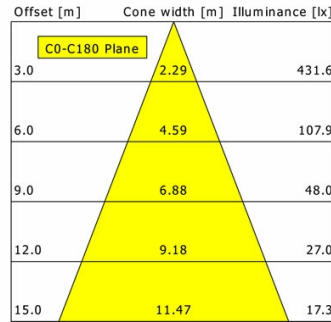

η	LED
Efficiency	98 lm/W
Direct/Indirect	↓ 100% / ↑ 0%
System Power	27 W
UGR	X=4H, Y=8H
Reflection factors	70/50/20
UGR C0/C180	25.9
UGR C90/C270	25.9
CIE Flux Codes	84 95 99 100 100
Ra/CRI	>80

LTS

FLIR 200.2027.35

Zubehör



FLIRZ 200.01
Dekorring schwarz



FLIRZ 200.02
Dekorring silber



FLIRZ 200.03
Dekorring weiß



FLIRZ 200.04
Lichteffektring opal



FLIRZ 200.05
Lichteffektring klar

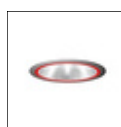

FLIRZ 200.06
Lichteffektring rot matt



FLIRZ 200.07
Lichteffektring gelb matt



FLIRZ 200.08
Lichteffektring blau matt



FLIRZ 200.16
Lichteffektring rot transluzent



FLIRZ 200.17
Lichteffektring gelb transluzent



FLIRZ 200.18
Lichteffektring blau transluzent

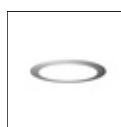

FLIRZ 200.24
Dekoglas opal



FLIRZ 200.25
Dekoglas klar