

FLIQ 400.3030.01

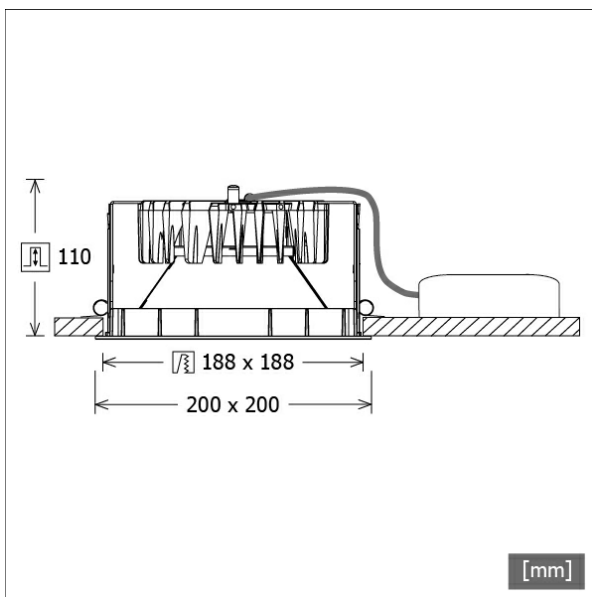

Farbe	Artikelnummer	EAN
schwarz	636483	4043544390653
silber	636484	4043544390660
weiß	636485	4043544390677



Beschreibung

- Einbau-Downlight mit optischen Designvarianten für Allgemeinbeleuchtung
- hohe Wartungsfreundlichkeit
- keine UV- und Wärmestrahlung
- innovatives Wärmemanagement mit Passivkühlung (Kühlkörper aus Aluminiumdruckguss)
- entspiegelter Mattreflektor aus Aluminium für maximale Lichtausbeute und optimale Entblendung
- Front-/Einbaurahmen aus Zinkdruckguss mit Lichteffektrahmen klar (weitere Dekor-/Lichteffektrahmen und Dekogläser sind als Option erhältlich)
- werkzeugloser Deckeneinbau mit Schnellspannautomatik (automatische Anpassung der Deckenstärke)
- Leuchte und Betriebsgerät über Kabel (Länge: 500 mm) fest verbunden, Betriebsgerät fertig für Netzanschluss
- Betriebsgerät (LED-Konverter) inklusive (Platzierung extern)

Standardoptionen

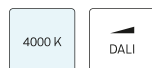

Sonderoptionen



Lichttechnik / Normen

Leuchtmittel	LED Modul / CRI 80 / 3000 K
EPREL Lichtquellen	891012
Lebensdauer	L90 B50 50.000 h L80 B50 100.000 h L80 B20 50.000 h
Systemleistung	26.0 W
Leuchten-Lichtstrom	max. 3240 lm
Systemeffizienz	124.61 lm/W
Moduleffizienz	167.99 lm/W
UGR Klasse	≤25
Versorgungsspannung	220 - 240 V / 50 - 60 Hz
Schutzklasse	II
Schutzart	IP20

Abmessungen / Gewichte

Länge	200 mm
Breite	200 mm
Höhe	112 mm
Ausschnittsmaß (LxB))	188 x 188 mm
Deckenstärke	5.0 - 50.0 mm
Einbautiefe	110 mm
Nettogewicht	1.21 kg
Bruttogewicht	1.27 kg

FLIQ 400.3030.01

Flixx 400 Square (FLIQZ 400.05, 1xLED 26W 830/3000K 3240lm)

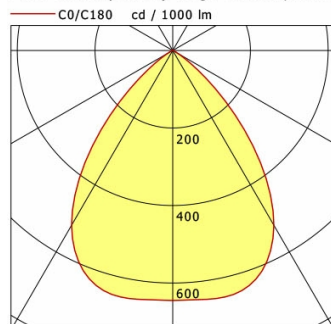

	C0	C90	C180	C270
0°	645	645	645	645
15°	647	647	647	647
30°	521	521	521	521
45°	209	209	209	209
60°	17	17	17	17
75°	4	4	4	4
90°	0	0	0	0

cd / 1000 lm

Offset [m]	Cone width [m]	Illuminance [lx]
3.0	5.01	232.2
6.0	10.01	58.1
9.0	15.02	25.8
12.0	20.03	14.5
15.0	25.03	9.3

η	LED
Efficiency	125 lm/W
Direct/Indirect	↓ 100% / ↑ 0%
System Power	26 W
UGR	X=4H, Y=8H
Reflection factors	70/50/20
UGR C0/C180	20.9
UGR C90/C270	20.9
CIE Flux Codes	81 99 100 100 100
Ra/CRI	>80

LTS

Flixx 400 Square (FLIQZ 400.24, 1xLED 26W 830/3000K 3100lm)

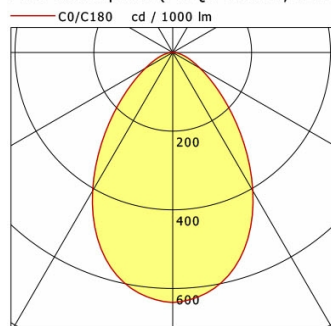

	C0	C90	C180	C270
0°	636	636	636	636
15°	577	577	577	577
30°	406	406	406	406
45°	204	204	204	204
60°	80	80	80	80
75°	27	27	27	27
90°	0	0	0	0

cd / 1000 lm

Offset [m]	Cone width [m]	Illuminance [lx]
3.0	4.40	218.9
6.0	8.80	54.7
9.0	13.19	24.3
12.0	17.59	13.7
15.0	21.99	8.8

η	LED
Efficiency	119 lm/W
Direct/Indirect	↓ 100% / ↑ 0%
System Power	26 W
UGR	X=4H, Y=8H
Reflection factors	70/50/20
UGR C0/C180	24.6
UGR C90/C270	24.6
CIE Flux Codes	67 91 98 100 100
Ra/CRI	>80

LTS

Flixx 400 Square (FLIQZ 400.25, 1xLED 26W 830/3000K 3170lm)

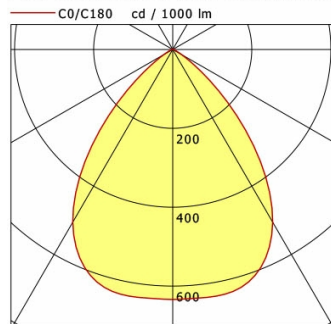

	C0	C90	C180	C270
0°	634	634	634	634
15°	630	630	630	630
30°	506	506	506	506
45°	213	213	213	213
60°	26	26	26	26
75°	5	5	5	5
90°	0	0	0	0

cd / 1000 lm

Offset [m]	Cone width [m]	Illuminance [lx]
3.0	5.04	223.3
6.0	10.08	55.8
9.0	15.12	24.8
12.0	20.16	14.0
15.0	25.19	8.9

η	LED
Efficiency	122 lm/W
Direct/Indirect	↓ 100% / ↑ 0%
System Power	26 W
UGR	X=4H, Y=8H
Reflection factors	70/50/20
UGR C0/C180	21.1
UGR C90/C270	21.1
CIE Flux Codes	79 98 100 100 100
Ra/CRI	>80

LTS

FLIQ 400.3030.01

Zubehör



FLIQZ 400.01
Dekorrahmen schwarz



FLIQZ 400.02
Dekorrahmen silber



FLIQZ 400.03
Dekorrahmen weiß



FLIQZ 400.04
Lichteffektrahmen opal



FLIQZ 400.05
Lichteffektrahmen klar



FLIQZ 400.06
Lichteffektrahmen rot matt



FLIQZ 400.07
Lichteffektrahmen gelb matt



FLIQZ 400.08
Lichteffektrahmen blau matt



FLIQZ 400.16
Lichteffektrahmen rot transluzent



FLIQZ 400.17
Lichteffektrahmen gelb transluzent



FLIQZ 400.18
Lichteffektrahmen blau transluzent



FLIQZ 400.24
Dekoglas opal



FLIQZ 400.25
Dekoglas klar



NOL 50B/3H/DALI
LED-Notlichteinheit



ZVP 100
Universalverstärkungsrahmen
(Modul 625 x 625)