

JAMIE 302.930.45.2/DALI-ST



Beschreibung

- flexibler Stromschienenstrahler in kompakter Bauform mit zylinderförmigem Design
- Leuchte 350° drehbar und 90° schwenkbar über integrierten Gelenkarm
- hohe Wartungsfreundlichkeit
- keine UV- und Wärmestrahlung
- Wärmemanagement über Gehäuse
- Spiegelreflektor aus Aluminium mit präziser symmetrischer Abstrahlcharakteristik für optimale Lichtausbeute und Entblendung
- Gehäusezylinder aus Aluminium
- Schutzglas klar
- 3-Phasen-Stromschienenadapter DALI (ONETrack)
- Betriebsgerät (LED-Konverter DALI, dimmbar) integriert

Standardoptionen



Sonderoptionen



Farbe	Artikelnummer	EAN
silber	662639	4043544716880
schwarz	662640	4043544716897
weiß	662641	4043544716903

Lichttechnik / Normen

Leuchtmittel	LED Spot / CRI 90 / 3000 K
EPREL Lichtquellen	851296
Lebensdauer	L90 B50 50.000 h
	L80 B50 100.000 h
	L80 B20 50.000 h
Systemleistung	24.6 W
Leuchten-Lichtstrom	2170 lm
Systemeffizienz	88.21 lm/W
Moduleffizienz	134.21 lm/W
UGR Klasse	≤22
Abstrahlbereich	Flood
Abstrahlwinkel	42°
Versorgungsspannung	220 - 240 V / 50 - 60 Hz
Schutzklasse	I
Schutzart	IP20

Abmessungen / Gewichte

Länge	108 mm
Breite	80 mm
Höhe	220 mm
Durchmesser Lichtkopf	80 mm
Nettogewicht	0.94 kg
Bruttogewicht	1.02 kg

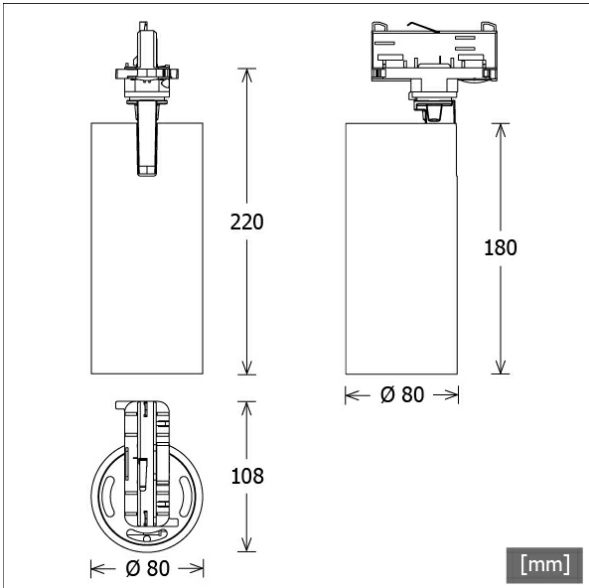

JAMIE 302.930.45.2/DALI-ST

Jamie 300 (1xLED 25W 930/3000K 2170lm 45 °)

C0/C180 cd / 1000 lm

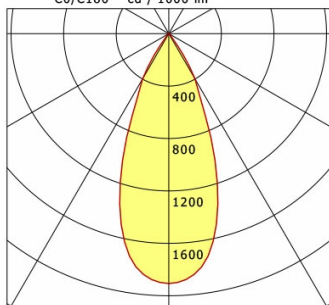

	C0	C90	C180	C270
0°	1907	1907	1907	1907
15°	1429	1429	1429	1429
30°	397	397	397	397
45°	17	17	17	17
60°	8	8	8	8
75°	6	6	6	6
90°	0	0	0	0

cd / 1000 lm

Offset [m] Cone width [m] Illuminance [lx]

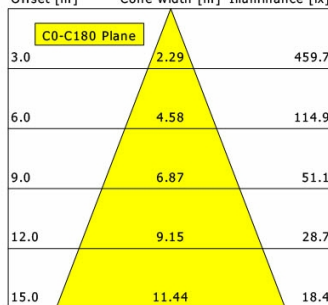

η	LED
Efficiency	87 lm/W
Direct/Indirect	↓ 100% / ↑ 0%
System Power	25 W
UGR	X=4H, Y=8H
Reflection factors	70/50/20
UGR C0/C180	20.0
UGR C90/C270	20.0
CIE Flux Codes	96 98 99 100 100
Ra/CRI	>90

LTS

Zubehör



ST-A 10/9000A-1-ST
Anbau-Stromschiene ONETrack Advance mit Datenbus
(Länge: 1000 mm)



ST-A 20/9000A-2-ST
Anbau-Stromschiene ONETrack Advance mit Datenbus
(Länge: 2000 mm)



ST-A 30/9000A-3-ST
Anbau-Stromschiene ONETrack Advance mit Datenbus
(Länge: 3000 mm)



ST-A 40/9000A-4-ST
Anbau-Stromschiene ONETrack Advance mit Datenbus
(Länge: 4000 mm)



ST-A MONO/9000-BPU-D
3-Phasen-Anbau-Monopoint mit Busoption



ST-E 10/9000-1-R
Einbau-Stromschiene ONETrack mit Datenbus
(Länge: 1000 mm)



ST-E 20/9000-2-R
Einbau-Stromschiene ONETrack mit Datenbus
(Länge: 2000 mm)



ST-E 30/9000-3-R
Einbau-Stromschiene ONETrack mit Datenbus
(Länge: 3000 mm)



ST-E 40/9000-4-R
Einbau-Stromschiene ONETrack mit Datenbus
(Länge: 4000 mm)



ST-E MONO/9000-BPU-D
3-Phasen-Einbau-Monopoint mit Busoption



ZB-OR DONGLE
Organic Response IR-Dongle-Set



ZB-OR GATEWAY
Organic Response IoT-Gateway Kaskadenserie

Stromschienenstrahler · Jamie 300



JAMIE 302.930.45.2/DALI-ST

Zubehör



ZB-OR-T SENSOR
Organic Response Sensor für
Stromschienenmontage



ZBK 12
Blendklappe



ZBW 85
Wabenraster