

FLIR-F 300.1040.01

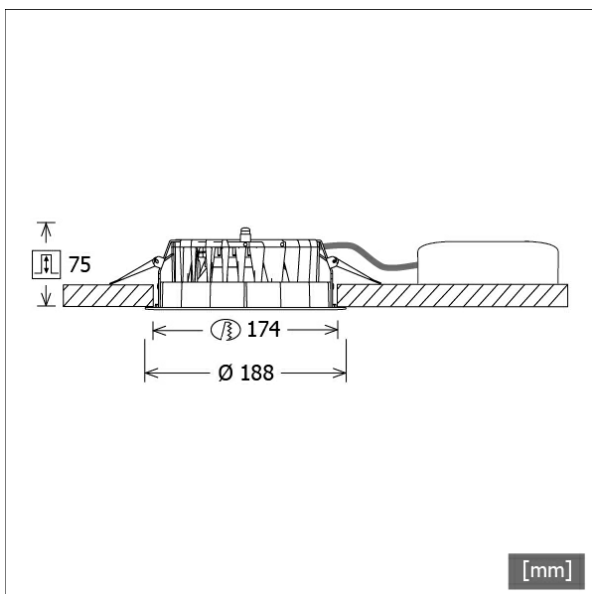

Farbe	Artikelnummer	EAN
schwarz	651610	4043544603838
silber	651611	4043544603845
weiß	651612	4043544603852



Beschreibung

- Einbau-Downlight mit optischen Designvarianten für Allgemeinbeleuchtung
- sehr geringe Einbautiefe
- hohe Wartungsfreundlichkeit
- keine UV- und Wärmestrahlung
- innovatives Wärmemanagement mit Passivkühlung (Kühlkörper aus Aluminiumdruckguss)
- High-Performance Spiegelreflektor aus Aluminium mit präziser symmetrischer Abstrahlcharakteristik für maximale Lichtausbeute und optimale Entblendung
- Front-/Einbauring aus Zinkdruckguss mit Lichteffektring klar (weitere Dekor-/Lichteffektringe und Dekogläser sind als Option erhältlich)
- werkzeugloser Deckeneinbau mit Schnellspannern (automatische Anpassung der Deckenstärke)
- Leuchte und Betriebsgerät über Kabel (Länge: 500 mm) fest verbunden, Betriebsgerät fertig für Netzanschluss
- Betriebsgerät (LED-Konverter) inklusive (Platzierung extern)

Standardoptionen



Sonderoptionen



Lichttechnik / Normen

Leuchtmittel	LED Modul / CRI 80 / 4000 K
EPREL Lichtquellen	891017
Lebensdauer	L90 B50 50.000 h L80 B50 100.000 h L80 B20 50.000 h
Systemleistung	11.0 W
Leuchten-Lichtstrom	max. 1100 lm
Systemeffizienz	97.27 lm/W
Moduleffizienz	122.35 lm/W
UGR Klasse	≤25
Abstrahlwinkel	85°
Versorgungsspannung	220 - 240 V / 50 - 60 Hz
Schutzklasse	II
Schutzart	IP20

Abmessungen / Gewichte

Außendurchmesser	188 mm
Höhe	77 mm
Ausschnittsmaß (∅)	174 mm
Deckenstärke	5.0 - 40.0 mm
Einbautiefe	75 mm
Nettogewicht	1.11 kg
Bruttogewicht	1.17 kg

FLIR-F 300.1040.01

Flixx 300 Flat Round (FLIRZ 300.25, 1xLED 11W 840/4000K 1070lm 85 °)

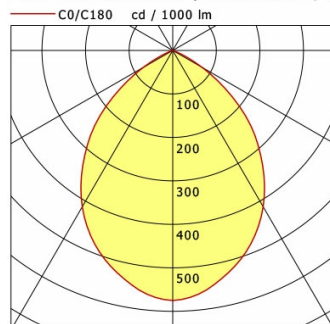

	C0	C90	C180	C270
0°	575	575	575	575
15°	522	522	522	522
30°	415	415	415	415
45°	261	261	261	261
60°	78	78	78	78
75°	4	4	4	4
90°	0	0	0	0

cd / 1000 lm

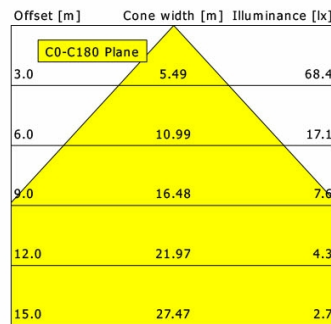

η	LED
Efficiency	97 lm/W
Direct/Indirect	↓ 100% / ↑ 0%
System Power	11 W
UGR	X=4H, Y=8H
Reflection factors	70/50/20
UGR C0/C180	21.4
UGR C90/C270	21.4
CIE Flux Codes	67 96 100 100 100
Ra/CRI	>80

LTS

Flixx 300 Flat Round (FLIRZ 300.24, 1xLED 11W 840/4000K 1030lm 85 °)

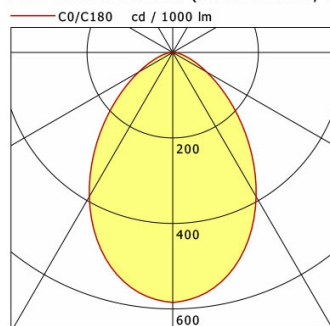

	C0	C90	C180	C270
0°	585	585	585	585
15°	529	529	529	529
30°	389	389	389	389
45°	221	221	221	221
60°	92	92	92	92
75°	27	27	27	27
90°	0	0	0	0

cd / 1000 lm

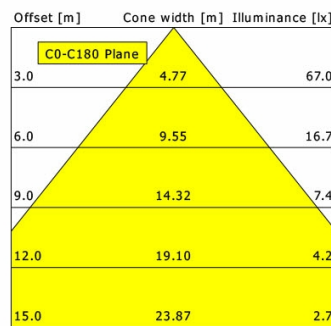

η	LED
Efficiency	94 lm/W
Direct/Indirect	↓ 100% / ↑ 0%
System Power	11 W
UGR	X=4H, Y=8H
Reflection factors	70/50/20
UGR C0/C180	22.9
UGR C90/C270	22.9
CIE Flux Codes	64 90 98 100 100
Ra/CRI	>80

LTS

Flixx 300 Flat Round (FLIRZ 300.05, 1xLED 11W 840/4000K 1100lm 85 °)

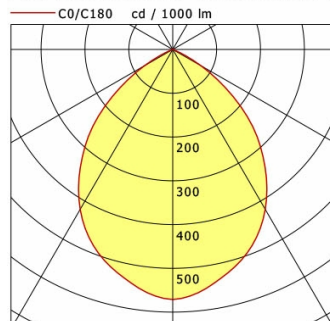

	C0	C90	C180	C270
0°	571	571	571	571
15°	520	520	520	520
30°	422	422	422	422
45°	265	265	265	265
60°	74	74	74	74
75°	1	1	1	1
90°	0	0	0	0

cd / 1000 lm

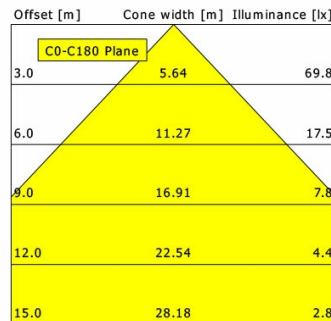

η	LED
Efficiency	100 lm/W
Direct/Indirect	↓ 100% / ↑ 0%
System Power	11 W
UGR	X=4H, Y=8H
Reflection factors	70/50/20
UGR C0/C180	21.4
UGR C90/C270	21.4
CIE Flux Codes	68 97 100 100 100
Ra/CRI	>80

LTS

FLIR-F 300.1040.01

Zubehör



FLIRZ 300.01
Dekorring schwarz



FLIRZ 300.02
Dekorring silber



FLIRZ 300.03
Dekorring weiß



FLIRZ 300.04
Lichteffektring opal



FLIRZ 300.05
Lichteffektring klar



FLIRZ 300.06
Lichteffektring rot matt



FLIRZ 300.07
Lichteffektring gelb matt



FLIRZ 300.08
Lichteffektring blau matt



FLIRZ 300.16
Lichteffektring rot transluzent



FLIRZ 300.17
Lichteffektring gelb transluzent



FLIRZ 300.18
Lichteffektring blau transluzent

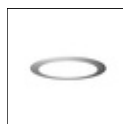

FLIRZ 300.24
Dekoglas opal



FLIRZ 300.25
Dekoglas klar



NOL 50B/3H/DALI
LED-Notlichteinheit



ZDAR 175.215-275
Ausgleichsring für Deckenausschnitte von 215 – 275 mm



ZVP 100
Universalverstärkungsrahmen
(Modul 625 x 625)