

# FLIQ 400.2040.01

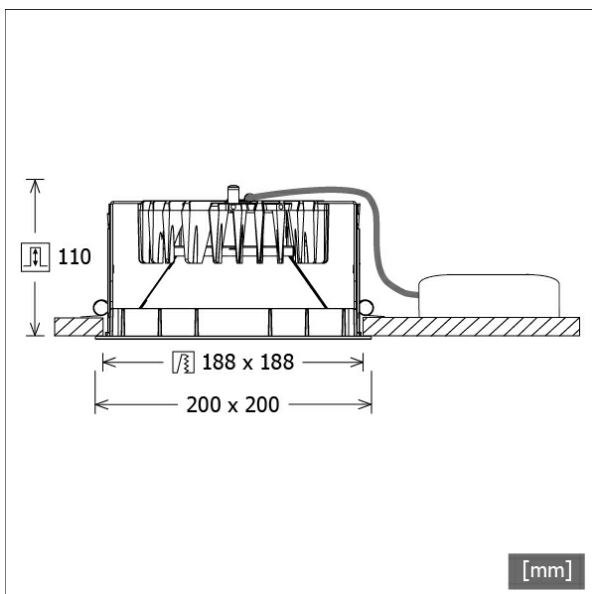

Farbe	Artikelnummer	EAN
schwarz	636474	4043544390561
silber	636475	4043544390578
weiß	636476	4043544390585



## Beschreibung

- Einbau-Downlight mit optischen Designvarianten für Allgemeinbeleuchtung
- hohe Wartungsfreundlichkeit
- keine UV- und Wärmestrahlung
- innovatives Wärmemanagement mit Passivkühlung (Kühlkörper aus Aluminiumdruckguss)
- entspiegelter Mattreflektor aus Aluminium für maximale Lichtausbeute und optimale Entblendung
- Front-/Einbaurahmen aus Zinkdruckguss mit Lichteffektrahmen klar (weitere Dekor-/Lichteffektrahmen und Dekogläser sind als Option erhältlich)
- werkzeugloser Deckeneinbau mit Schnellspannautomatik (automatische Anpassung der Deckenstärke)
- Leuchte und Betriebsgerät über Kabel (Länge: 500 mm) fest verbunden, Betriebsgerät fertig für Netzanschluss
- Betriebsgerät (LED-Konverter) inklusive (Platzierung extern)

## Standardoptionen



## Sonderoptionen



## Lichttechnik / Normen

Leuchtmittel	LED Modul / CRI 80 / 4000 K
EPREL Lichtquellen	891010
Lebensdauer	L90 B50 50.000 h L80 B50 100.000 h L80 B20 50.000 h
Systemleistung	21.0 W
Leuchten-Lichtstrom	max. 2590 lm
Systemeffizienz	123.33 lm/W
Moduleffizienz	173.48 lm/W
UGR Klasse	≤25
Versorgungsspannung	220 - 240 V / 50 - 60 Hz
Schutzklasse	II
Schutzart	IP20

## Abmessungen / Gewichte

Länge	200 mm
Breite	200 mm
Höhe	112 mm
Ausschnittsmaß (LxB))	188 x 188 mm
Deckenstärke	5.0 - 50.0 mm
Einbautiefe	110 mm
Nettogewicht	1.21 kg
Bruttogewicht	1.27 kg

# FLIQ 400.2040.01

Flixx 400 Square (FLIQZ 400.05, 1xLED 21W 840/4000K 2590lm)

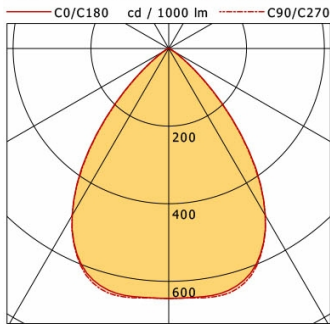

	C0	C90	C180	C270
0°	644	644	644	644
15°	639	647	639	647
30°	496	496	496	496
45°	178	174	178	174
60°	16	15	16	15
75°	4	4	4	4
90°	0	0	0	0
cd / 1000 lm				

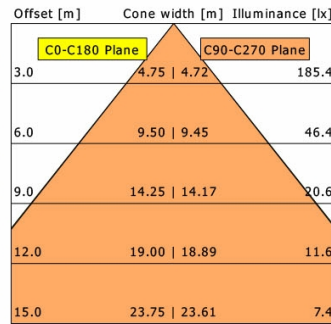

<b>η</b>	LED
Efficiency	123 lm/W
Direct/Indirect	↓ 100% / ↑ 0%
System Power	21 W
<b>UGR</b>	X=4H, Y=8H
Reflection factors	70/50/20
UGR C0/C180	20.1
UGR C90/C270	20.0
CIE Flux Codes	81 99 100 100 100
Ra/CRI	>80

LTS

Flixx 400 Square (FLIQZ 400.24, 1xLED 21W 840/4000K 2480lm)

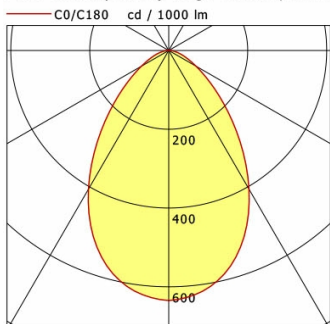

	C0	C90	C180	C270
0°	635	635	635	635
15°	577	577	577	577
30°	407	407	407	407
45°	204	204	204	204
60°	80	80	80	80
75°	27	27	27	27
90°	0	0	0	0
cd / 1000 lm				

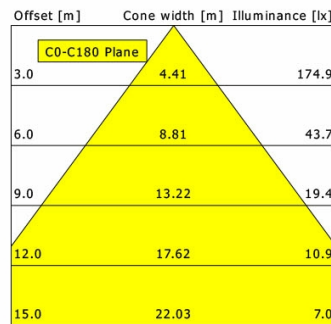

<b>η</b>	LED
Efficiency	118 lm/W
Direct/Indirect	↓ 100% / ↑ 0%
System Power	21 W
<b>UGR</b>	X=4H, Y=8H
Reflection factors	70/50/20
UGR C0/C180	23.8
UGR C90/C270	23.8
CIE Flux Codes	67 91 98 100 100
Ra/CRI	>80

LTS

Flixx 400 Square (FLIQZ 400.25, 1xLED 21W 840/4000K 2540lm)

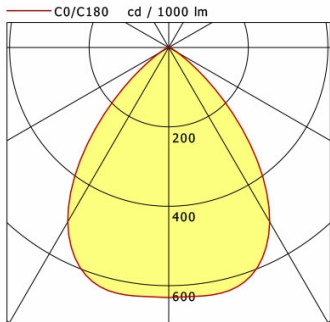

	C0	C90	C180	C270
0°	630	630	630	630
15°	629	629	629	629
30°	507	507	507	507
45°	213	213	213	213
60°	25	25	25	25
75°	5	5	5	5
90°	0	0	0	0
cd / 1000 lm				

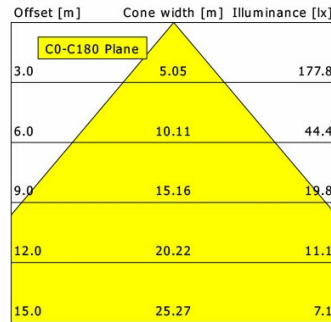

<b>η</b>	LED
Efficiency	121 lm/W
Direct/Indirect	↓ 100% / ↑ 0%
System Power	21 W
<b>UGR</b>	X=4H, Y=8H
Reflection factors	70/50/20
UGR C0/C180	20.4
UGR C90/C270	20.4
CIE Flux Codes	79 98 100 100 100
Ra/CRI	>80

LTS

# FLIQ 400.2040.01

## Zubehör



**FLIQZ 400.01**  
Dekorrahmen schwarz



**FLIQZ 400.02**  
Dekorrahmen silber



**FLIQZ 400.03**  
Dekorrahmen weiß



**FLIQZ 400.04**  
Lichteffektrahmen opal



**FLIQZ 400.05**  
Lichteffektrahmen klar



**FLIQZ 400.06**  
Lichteffektrahmen rot matt



**FLIQZ 400.07**  
Lichteffektrahmen gelb matt



**FLIQZ 400.08**  
Lichteffektrahmen blau matt



**FLIQZ 400.16**  
Lichteffektrahmen rot transluzent



**FLIQZ 400.17**  
Lichteffektrahmen gelb transluzent



**FLIQZ 400.18**  
Lichteffektrahmen blau transluzent



**FLIQZ 400.24**  
Dekoglas opal



**FLIQZ 400.25**  
Dekoglas klar



**NOL 50B/3H/DALI**  
LED-Notlichteinheit



**ZVP 100**  
Universalverstärkungsrahmen  
(Modul 625 x 625)