

# SCEKLP 6.3040.35/DALI

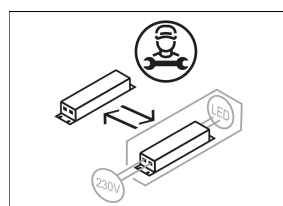

Farbe	Artikelnummer	EAN
schwarz	645181	4043544517449
silber	645182	4043544517456
weiß	645183	4043544517463

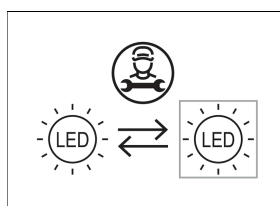
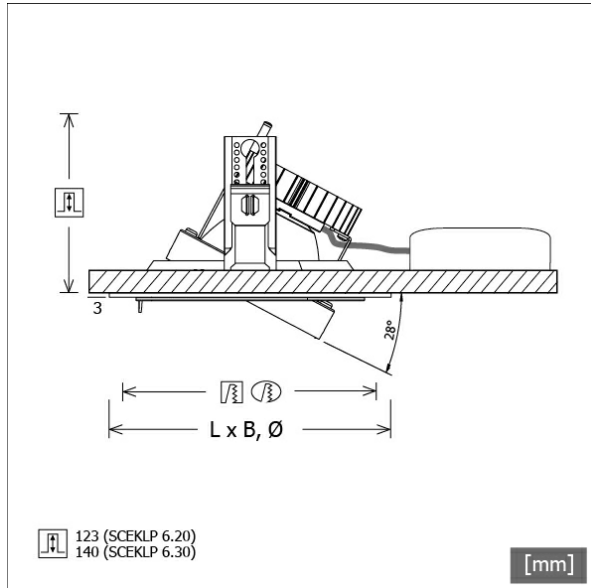

## Beschreibung

- flexibles Einbaustrahlersystem bestehend aus Einbaurahmen, Lichtköpfen und Betriebsgeräten (Einbaurahmen separat bestellen)
- Lichtkopf 28° kardanisch schwenkbar
- hohe Wartungsfreundlichkeit
- keine UV- und Wärmestrahlung
- Wärmemanagement mit Passivkühlung (Kühlkörper aus Aluminium)
- Kardanringe aus Zinkdruckguss und Polycarbonat
- Spiegelreflektor aus Aluminium mit präziser symmetrischer Abstrahlcharakteristik für optimale Lichtausbeute und Entblendung
- Schutzglas klar
- werkzeugloses Einrasten des Lichtkopfes in Einbaurahmen
- Anschluss an Betriebsgerät über Leuchtenkabel mit Mini-Clamp Steckverbindung
- Betriebsgerät (LED-Konverter DALI, dimmbar) inklusive (Platzierung extern)

## Standardoptionen



## Sonderoptionen

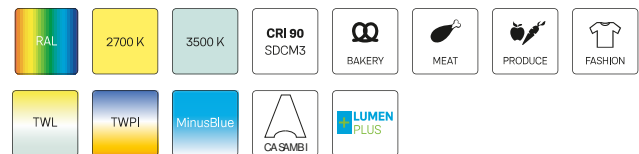

## Lichttechnik / Normen

Leuchtmittel	LED Spot / CRI 80 / 4000 K
EPREL Lichtquellen	851282
Lebensdauer	L90 B50 50.000 h
	L80 B50 100.000 h
	L80 B20 50.000 h
Systemleistung	32,8 W
Leuchten-Lichtstrom	3740 lm
Systemeffizienz	114,02 lm/W
Moduleffizienz	162,17 lm/W
UGR Klasse	≤22
Abstrahlbereich	Flood
Abstrahlwinkel	33°
Versorgungsspannung	220 - 240 V / 50 - 60 Hz
Schutzklasse	III
Schutzart	IP20

## Abmessungen / Gewichte

Höhe	143 mm
Einbautiefe	140 mm
Durchmesser Lichtkopf	154 mm
Nettogewicht	1,00 kg
Bruttogewicht	1,05 kg

# SCEKLP 6.3040.35/DALI

## SCEKLP 6.3040.35/DALI

Scene 6 System | Light-Head (1xLED 33W 840/4000K 3740lm)

C0/C180 cd / 1000 lm

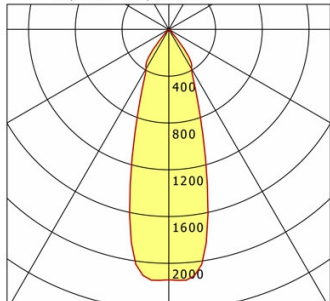

	C0	C90	C180	C270
0°	2141	2141	2141	2141
15°	1247	1247	1247	1247
30°	389	389	389	389
45°	18	18	18	18
60°	4	4	4	4
75°	0	0	0	0
90°	0	0	0	0

cd / 1000 lm

Offset [m] Cone width [m] Illuminance [lx]

Offset [m]	Cone width [m]	Illuminance [lx]
3.0	1.80	889.9
6.0	3.59	222.5
9.0	5.39	98.9
12.0	7.19	55.6
15.0	8.99	35.6

<b>η</b>	LED
Efficiency	113 lm/W
Direct/Indirect	↓ 100% / ↑ 0%
System Power	33 W
<b>UGR</b>	X=4H, Y=8H
Reflection factors	70/50/20
UGR C0/C180	20.7
UGR C90/C270	20.7
CIE Flux Codes	98 100 100 100 100
Ra/CRI	>80

LTS

## Zubehör

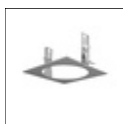

**SCER 6.100**  
Einbaurahmen 1-flammig



**SCER 6.111**  
Einbaurahmen (rund) 1-flammig

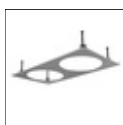

**SCER 6.200**  
Einbaurahmen 2-flammig

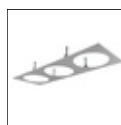

**SCER 6.300**  
Einbaurahmen 3-flammig



**SCER 6.310**  
Einbaurahmen (rund) 3-flammig

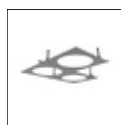

**SCER 6.330**  
Einbau-Eckrahmen 3-flammig

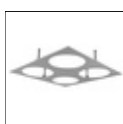

**SCER 6.400**  
Einbaurahmen 4-flammig



**ZB-OR DONGLE**  
Organic Response IR-Dongle-Set



**ZB-OR GATEWAY**  
Organic Response IoT-Gateway Kaskadenserie



**ZB-OR-R SENSOR**  
Organic Response Sensor für Einbaumontage