

JAMIE 301.940.15.2



Beschreibung

- flexibler Stromschienenstrahler in kompakter Bauform mit zylinderförmigem Design
- Leuchte 350° drehbar und 90° schwenkbar über integrierten Gelenkarm
- hohe Wartungsfreundlichkeit
- keine UV- und Wärmestrahlung
- Wärmemanagement über Gehäuse
- Spiegelreflektor aus Aluminium mit präziser symmetrischer Abstrahlcharakteristik für optimale Lichtausbeute und Entblendung
- Gehäusezylinder aus Aluminium
- Schutzglas klar
- 3-Phasen-Stromschienenadapter
- Betriebsgerät (LED-Konverter) integriert

Standardoptionen



Sonderoptionen



Farbe	Artikelnummer	EAN
schwarz	658010	4043544669285
silber	658011	4043544669292
weiß	658012	4043544669308

Lichttechnik / Normen

Leuchtmittel	LED Spot / CRI 90 / 4000 K
EPREL Lichtquellen	851045
Lebensdauer	L90 B50 50.000 h L80 B50 100.000 h L80 B20 50.000 h
Systemleistung	16.0 W
Leuchten-Lichtstrom	1450 lm
Systemeffizienz	90.62 lm/W
Moduleffizienz	139.42 lm/W
UGR Klasse	≤19
Abstrahlbereich	Spot
Abstrahlwinkel	21°
Versorgungsspannung	220 - 240 V / 50 - 60 Hz
Schutzklasse	I
Schutzart	IP20

Abmessungen / Gewichte

Länge	125 mm
Breite	80 mm
Höhe	215 mm
Durchmesser Lichtkopf	80 mm
Nettogewicht	0.84 kg
Bruttogewicht	0.94 kg

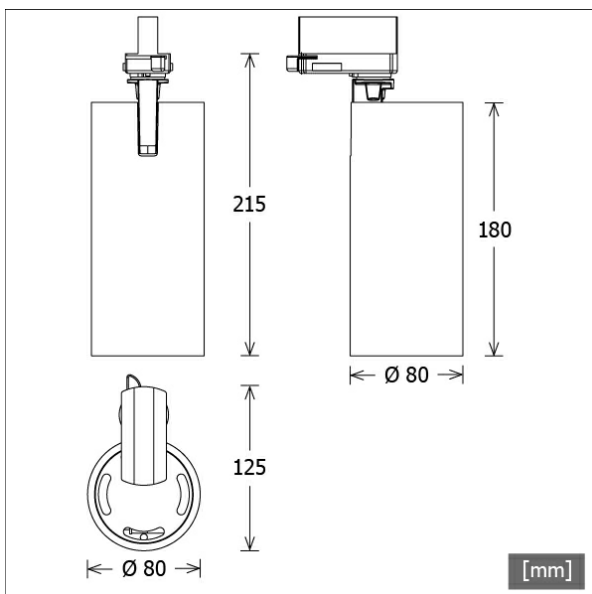

JAMIE 301.940.15.2

Jamie 300 (1xLED 16W 940/4000K 1450lm 15 °)

C0/C180 cd / 1000 lm

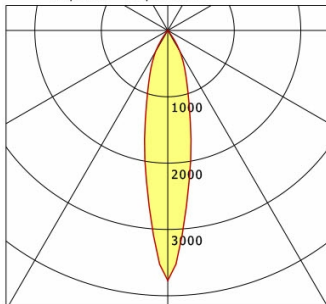

	C0	C90	C180	C270
0°	3770	3770	3770	3770
15°	1275	1275	1275	1275
30°	366	366	366	366
45°	14	14	14	14
60°	12	12	12	12
75°	5	5	5	5
90°	0	0	0	0
cd / 1000 lm				

Offset [m] Cone width [m] Illuminance [lx]

Offset [m]	Cone width [m]	Illuminance [lx]
3.0	1.13	607.4
6.0	2.26	151.9
9.0	3.39	67.5
12.0	4.52	38.0
15.0	5.65	24.3

η	LED
Efficiency	91 lm/W
Direct/Indirect	↓ 100% / ↑ 0%
System Power	16 W
UGR	X=4H, Y=8H
Reflection factors	70/50/20
UGR C0/C180	17.7
UGR C90/C270	17.7
CIE Flux Codes	96 99 100 100 100
Ra/CRI	>90

LTS

Zubehör



ST-A 10/9000A-1-ST
Anbau-Stromschiene ONETrack Advance mit Datenbus
(Länge: 1000 mm)



ST-A 20/9000A-2-ST
Anbau-Stromschiene ONETrack Advance mit Datenbus
(Länge: 2000 mm)



ST-A 30/9000A-3-ST
Anbau-Stromschiene ONETrack Advance mit Datenbus
(Länge: 3000 mm)



ST-A 40/9000A-4-ST
Anbau-Stromschiene ONETrack Advance mit Datenbus
(Länge: 4000 mm)



ST-A MONO/9000-BPU-D
3-Phasen-Anbau-Monopoint mit Busoption



ST-E 10/9000-1-R
Einbau-Stromschiene ONETrack mit Datenbus
(Länge: 1000 mm)



ST-E 20/9000-2-R
Einbau-Stromschiene ONETrack mit Datenbus
(Länge: 2000 mm)



ST-E 30/9000-3-R
Einbau-Stromschiene ONETrack mit Datenbus
(Länge: 3000 mm)



ST-E 40/9000-4-R
Einbau-Stromschiene ONETrack mit Datenbus
(Länge: 4000 mm)



ST-E MONO/9000-BPU-D
3-Phasen-Einbau-Monopoint mit Busoption



ZBK 12
Blendklappe



ZBW 85
Wabenraster