

STRL 610.0845.840/DALI

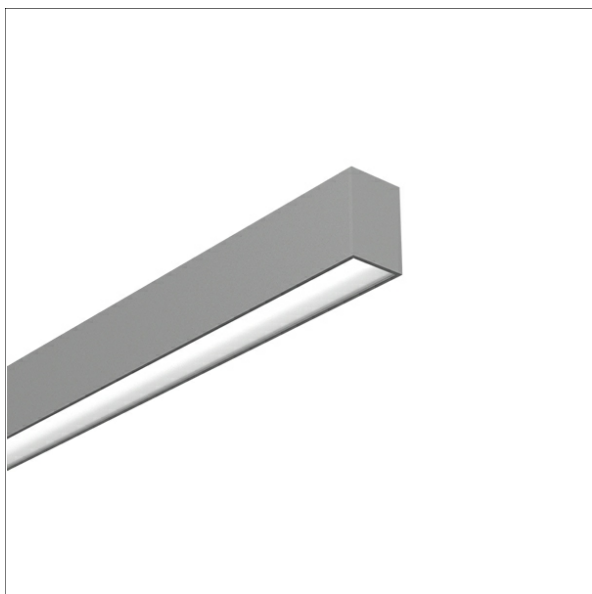

Farbe	Artikelnummer	EAN
silber eloxiert	667751	4043544770981
schwarz	667752	4043544770998
weiß	667753	4043544771001

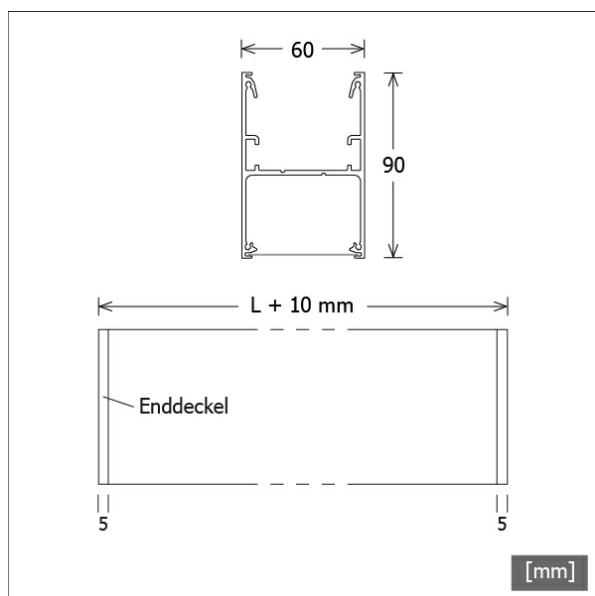

Beschreibung

- Lichtbandsystem für Decken- oder Pendelmontage
- Lichtmodule in verschiedenen Fixlängen zur Realisierung von variablen Lichtlinien (auch für sehr große Längen geeignet)
- hohe Wartungsfreundlichkeit
- keine UV- und Wärmestrahlung
- Modulgehäuse aus hochwertig extrudiertem Aluminiumprofil
- integriertes LED-Lichtband mit gewölbtem PMMA-Diffusor für homogene Lichtverteilung Lichtlenkung durch hocheffiziente nanoOptix-Folien von LTS mit Mikrolinsenstruktur und verschiedene Abstrahlcharakteristiken (Batwing/breitstrahlend, tiefstrahlend) oder über Standardfolie "opal diffus", LTS-nanoOptix-Folien sind optional erhältlich bis 150 m Länge (Vorteile: keine Stoßkanten, durchgängiges homogenes Lichtbild über die ganze Folienlänge)
- Enddeckel, Lichtlenkungsfolien und erforderliche Systemkomponenten separat bestellen
- Modul ohne Lichtlenkungsfolien
- Montage über Anbauklammern oder Drahtseilabhängung
- steckerfertig für Durchgangsverdrahtung
- Betriebsgerät (LED-Konverter DALI, dimmbar) integriert

Hinweise

Die thermische Längenausdehnung des Aluminiumprofils beträgt bei $\Delta T = 10$ Kelvin 0.3 mm pro Meter.

Standardoptionen



Sonderoptionen



Lichttechnik / Normen

Leuchtmittel	LED linear / CRI 80 / 4000 K
EPREL Lichtquellen	833900 833895
Lebensdauer	L90 B50 50.000 h L80 B50 100.000 h L80 B20 50.000 h
Systemleistung	22.2 W
Leuchten-Lichtstrom	max. 2640 lm
Systemeffizienz	104.95 lm/W
Moduleffizienz	187.83 lm/W
UGR Klasse	≤28
Versorgungsspannung	220 - 240 V / 50 - 60 Hz
Schutzklasse	I
Schutzart	IP20

Abmessungen / Gewichte

Länge	845 mm
Breite	60 mm
Höhe	90 mm
Nettogewicht	2.55 kg
Bruttogewicht	2.69 kg

STRL 610.0845.840/DALI

StraitLine | Light-Module (Opal Diffuse_si_wh, 1xLED 22W 840/4000K 2330lm)

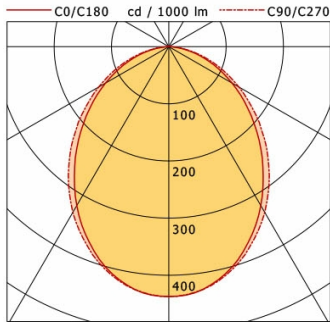

	C0	C90	C180	C270
0°	437	437	437	437
15°	405	409	405	409
30°	321	335	321	335
45°	220	239	220	239
60°	128	141	128	141
75°	51	57	51	57
90°	0	0	0	0
cd / 1000 lm				

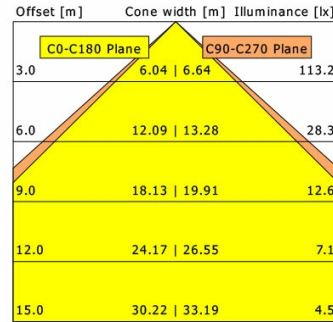

η	LED
Efficiency	106 lm/W
Direct/Indirect	↓ 100% / ↑ 0%
System Power	22 W
UGR	X=4H, Y=8H
Reflection factors	70/50/20
UGR C0/C180	25.0
UGR C90/C270	25.5
CIE Flux Codes	53 83 97 100 100
Ra/CRI	>80

LTS

StraitLine | Light-Module (Deep Beam nanoOptix_si_wh, 1xLED 22W 840/4000K 2430lm)

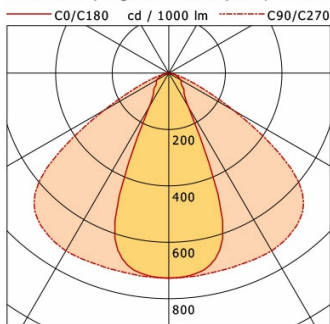

	C0	C90	C180	C270
0°	727	727	727	727
15°	667	724	667	724
30°	138	728	138	728
45°	69	673	69	673
60°	49	267	49	267
75°	23	33	23	33
90°	0	0	0	0
cd / 1000 lm				

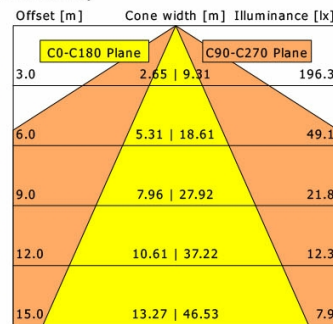

η	LED
Efficiency	110 lm/W
Direct/Indirect	↓ 100% / ↑ 0%
System Power	22 W
UGR	X=4H, Y=8H
Reflection factors	70/50/20
UGR C0/C180	19.0
UGR C90/C270	24.7
CIE Flux Codes	71 92 99 100 100
Ra/CRI	>80

LTS

StraitLine | Light-Module (Batwing/Wide Beam nanoOptix_si_wh, 1xLED 22W 840/4000K 2640lm)

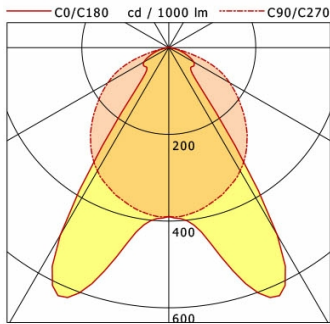

	C0	C90	C180	C270
0°	390	390	390	390
15°	516	372	516	372
30°	499	328	499	328
45°	71	251	71	251
60°	66	161	66	161
75°	25	46	25	46
90°	0	0	0	0
cd / 1000 lm				

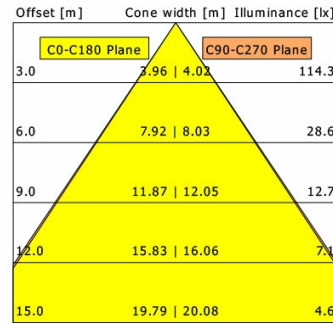

η	LED
Efficiency	120 lm/W
Direct/Indirect	↓ 100% / ↑ 0%
System Power	22 W
UGR	X=4H, Y=8H
Reflection factors	70/50/20
UGR C0/C180	20.9
UGR C90/C270	24.9
CIE Flux Codes	66 90 99 100 100
Ra/CRI	>80

LTS

StraitLine | Light-Module (Opal Diffuse_bk, 1xLED 22W 840/4000K 1950lm)

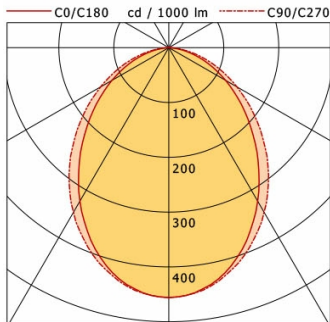

	C0	C90	C180	C270
0°	456	456	456	456
15°	418	424	418	424
30°	323	347	323	347
45°	213	245	213	245
60°	119	143	119	143
75°	45	57	45	57
90°	0	0	0	0
cd / 1000 lm				

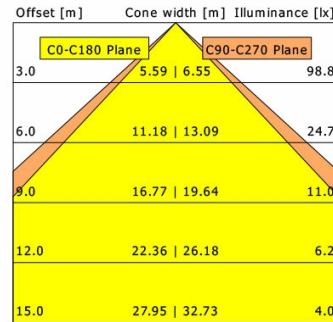

η	LED
Efficiency	89 lm/W
Direct/Indirect	↓ 100% / ↑ 0%
System Power	22 W
UGR	X=4H, Y=8H
Reflection factors	70/50/20
UGR C0/C180	23.8
UGR C90/C270	24.8
CIE Flux Codes	54 83 97 100 100
Ra/CRI	>80

LTS

STRL 610.0845.840/DALI

StraitLine | Light-Module (Deep Beam nanoOptix_bk, 1xLED 22W 840/4000K 2090lm)

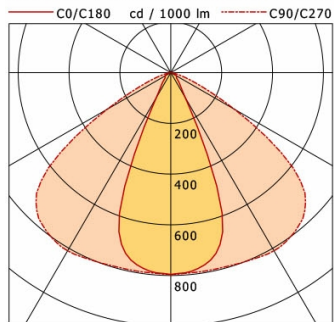

	C0	C90	C180	C270
0°	796	796	796	796
15°	721	795	721	795
30°	114	811	114	811
45°	35	748	35	748
60°	26	290	26	290
75°	10	33	10	33
90°	0	0	0	0

cd / 1000 lm

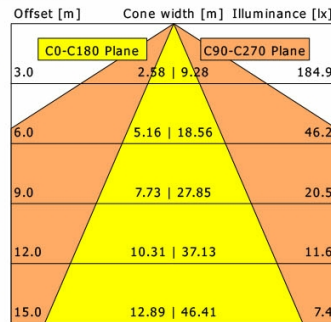

η	LED
Efficiency	95 lm/W
Direct/Indirect	↓ 100% / ↑ 0%
System Power	22 W
UGR	X=4H, Y=8H
Reflection factors	70/50/20
UGR C0/C180	13.8
UGR C90/C270	24.4
CIE Flux Codes	75 94 99 100 100
Ra/CRI	>80

LTS

StraitLine | Light-Module (Batwing/Wide Beam nanoOptix_bk, 1xLED 22W 840/4000K 2280lm)

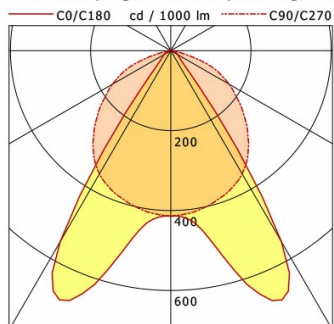

	C0	C90	C180	C270
0°	414	414	414	414
15°	548	396	548	396
30°	552	356	552	356
45°	41	269	41	269
60°	20	168	20	168
75°	8	46	8	46
90°	0	0	0	0

cd / 1000 lm

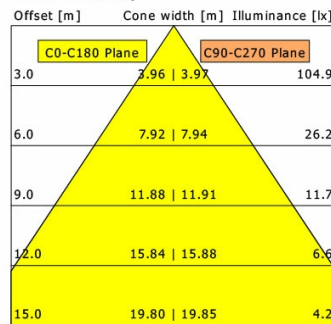

η	LED
Efficiency	104 lm/W
Direct/Indirect	↓ 100% / ↑ 0%
System Power	22 W
UGR	X=4H, Y=8H
Reflection factors	70/50/20
UGR C0/C180	16.5
UGR C90/C270	24.6
CIE Flux Codes	71 94 99 100 100
Ra/CRI	>80

LTS

STRL 610.0845.840/DALI

Zubehör



STRL-LK-Z070-060.102.00
Verbinder-Set linear



STRL-LK060-Z690.BW-WB.03
Lichtlenkungsfolie nanoOptix "Batwing und breitstrahlend"
(Länge: 3 m)



STRL-LK060-Z690.BW-WB.05
Lichtlenkungsfolie nanoOptix "Batwing und breitstrahlend"
(Länge: 5 m)



STRL-LK060-Z690.BW-WB.10
Lichtlenkungsfolie nanoOptix "Batwing und breitstrahlend"
(Länge: 10 m)



STRL-LK060-Z690.BW-WB.15
Lichtlenkungsfolie nanoOptix "Batwing und breitstrahlend"
(Länge: 15 m)



STRL-LK060-Z690.BW-WB.20
Lichtlenkungsfolie nanoOptix "Batwing und breitstrahlend"
(Länge: 20 m)



STRL-LK060-Z690.BW-WB.25
Lichtlenkungsfolie nanoOptix "Batwing und breitstrahlend"
(Länge: 25 m)



STRL-LK060-Z690.BW-WB.30
Lichtlenkungsfolie nanoOptix "Batwing und breitstrahlend"
(Länge: 30 m)



STRL-LK060-Z690.DB.03
Lichtlenkungsfolie nanoOptix "tiefstrahlend"
(Länge: 3 m)



STRL-LK060-Z690.DB.05
Lichtlenkungsfolie nanoOptix "tiefstrahlend"
(Länge: 5 m)



STRL-LK060-Z690.DB.10
Lichtlenkungsfolie nanoOptix "tiefstrahlend"
(Länge: 10 m)



STRL-LK060-Z690.DB.15
Lichtlenkungsfolie nanoOptix "tiefstrahlend"
(Länge: 15 m)



STRL-LK060-Z690.DB.20
Lichtlenkungsfolie nanoOptix "tiefstrahlend"
(Länge: 20 m)



STRL-LK060-Z690.DB.25
Lichtlenkungsfolie nanoOptix "tiefstrahlend"
(Länge: 25 m)



STRL-LK060-Z690.DB.30
Lichtlenkungsfolie nanoOptix "tiefstrahlend"
(Länge: 30 m)



STRL-LK060-Z690.OPDF.03
Lichtlenkungsfolie "opal diffus"
(Länge: 3 m)



STRL-LK060-Z690.OPDF.05
Lichtlenkungsfolie "opal diffus"
(Länge: 5 m)



STRL-LK060-Z690.OPDF.10
Lichtlenkungsfolie "opal diffus"
(Länge: 10 m)

STRL 610.0845.840/DALI

Zubehör



STRL-LK060-Z 690.OPDF.15
Lichtlenkungsfolie "opal diffus"
(Länge: 15 m)



STRL-LK060-Z 690.OPDF.20
Lichtlenkungsfolie "opal diffus"
(Länge: 20 m)



STRL-LK060-Z 690.OPDF.25
Lichtlenkungsfolie "opal diffus"
(Länge: 25 m)



STRL-LK060-Z 690.OPDF.30
Lichtlenkungsfolie "opal diffus"
(Länge: 30 m)

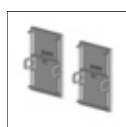

STRL-LKDI-Z 060.001
Enddeckel
(2 Stück)

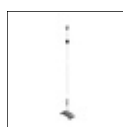

STRL-LKDI-Z 060.104.03
Drahtseil-Set ohne Einspeisung
(Länge: 3000 mm)



STRL-Z 100.05/DIM
Einspeise-Set
(Kabel 5-adrig, Länge: 5000 mm)

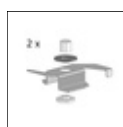

STRL-Z 104
Anbauklammern
(2 Stück)



STRL-Z 115
Linearverbinder für Deckenmontage
(1 Stück)



ZB-OR DONGLE
Organic Response IR-Dongle-Set



ZB-OR GATEWAY
Organic Response IoT-Gateway Kaskadenserie



ZB-OR-A SENSOR
Organic Response Sensor für Anbaumontage



ZB-OR-P SENSOR/3000
Organic Response Sensor für Pendelmontage