

LK-L 060.11840.1125.1/DALI



Beschreibung

- Lichteinsatz mit integrierten LED-Lichtstreifen
- Reflektor aus verkehrsweiß lackiertem Aluminiumblech
- keine UV- und Wärmestrahlung
- nahezu alle Lichtbandlängen realisierbar
- inklusive Leitung-Set (5-polig)
- PMMA-Mattfolie für gleichmäßige Lichtverteilung
- werkzeugloses Einrasten in Lichtkanal-Profil über Einbaufedern
- 5-polige Anschlussklemme, konfektioniert für Durchgangsverdrahtung
- Betriebsgerät (LED-Konverter DALI, dimmbar) integriert

Hinweise

Die thermische Längenausdehnung des Aluminiumprofils beträgt bei $dT = 10$ Kelvin 0.3 mm pro Meter.

Standardoptionen



Farbe	Artikelnummer	EAN
	667910	4043544795571

Sonderoptionen



Lichttechnik / Normen

Leuchtmittel	LED linear / CRI 80 / 4000 K
Lebensdauer	L90 B50 50.000 h L80 B50 100.000 h L80 B20 50.000 h
Systemleistung	25.5 W
Leuchten-Lichtstrom	max. 4260 lm
Systemeffizienz	158.82 lm/W
Moduleffizienz	205.00 lm/W
UGR Klasse	≤28
Versorgungsspannung	220 - 240 V / 50 - 60 Hz
Schutzklasse	I

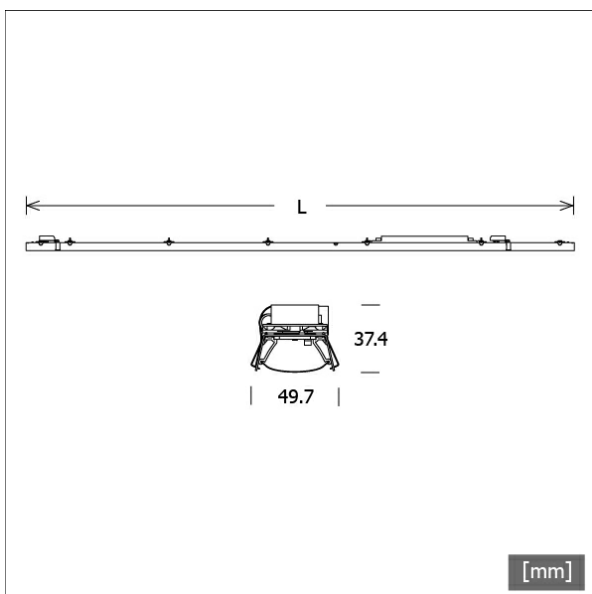

Abmessungen / Gewichte

Länge	1125 mm
Breite	50 mm
Höhe	37 mm
Nettogewicht	0.95 kg
Bruttogewicht	1.00 kg



LK-L 060.11840.1125.1/DALI

LK-L 060.11840.1125.1/DALI

Lichtkanal 060 | Light-Insert (Wallwasher nanoOptix, 1xLED 26W 840/4000K 4050lm)

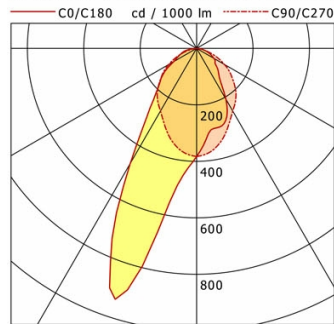

	C0	C90	C180	C270
0°	383	383	383	383
15°	290	339	848	339
30°	208	256	471	256
45°	107	193	191	193
60°	71	114	93	114
75°	33	37	50	37
90°	0	0	0	0

cd / 1000 lm

LDC unsuitable for cone representation.
Asymmetric LDC.

η		LED
Efficiency		156 lm/W
Direct/Indirect		↓ 100% / ↑ 0%
System Power		26 W
UGR		X=4H, Y=8H
Reflection factors		70/50/20
UGR C0/C180		22.5
UGR C90/C270		26.1
CIE Flux Codes		58 85 97 100 100
Ra/CRI		>80

LTS

LK-L 060.11840.1125.1/DALI

Lichtkanal 060 | Light-Insert (AOV-002/005.2, 1xLED 26W 840/4000K 4010lm)

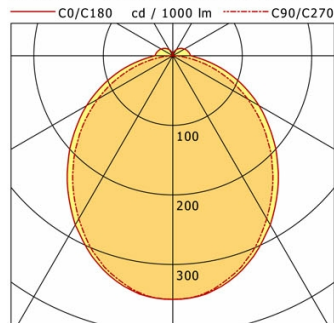

	C0	C90	C180	C270
0°	350	350	350	350
15°	332	328	332	328
30°	281	271	281	271
45°	213	200	213	200
60°	143	125	143	125
75°	75	51	75	51
90°	26	1	26	1

cd / 1000 lm

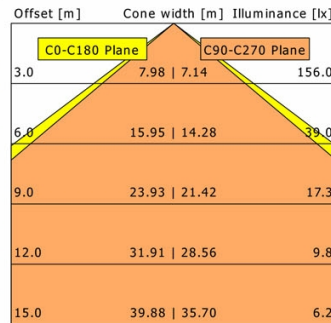

η		LED
Efficiency		154 lm/W
Direct/Indirect		↓ 93% / ↑ 7%
System Power		26 W
UGR		X=4H, Y=8H
Reflection factors		70/50/20
UGR C0/C180		27.5
UGR C90/C270		25.7
CIE Flux Codes		48 78 94 93 100
Ra/CRI		>80

LTS

LK-L 060.11840.1125.1/DALI

Lichtkanal 060 | Light-Insert (Batwing/Wide Beam nanoOptix, 1xLED 26W 840/4000K 4260lm)

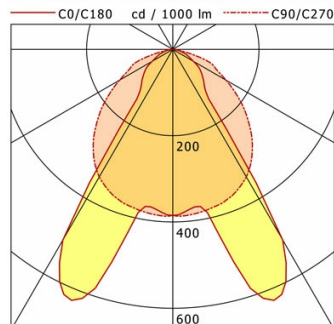

	C0	C90	C180	C270
0°	385	385	385	385
15°	476	377	476	377
30°	510	342	510	342
45°	101	253	101	253
60°	55	143	55	143
75°	21	53	21	53
90°	0	0	0	0

cd / 1000 lm

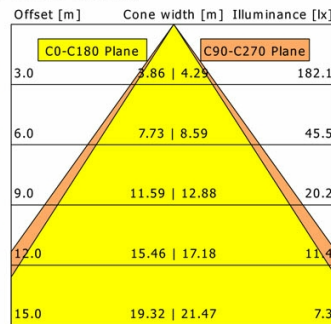

η		LED
Efficiency		164 lm/W
Direct/Indirect		↓ 100% / ↑ 0%
System Power		26 W
UGR		X=4H, Y=8H
Reflection factors		70/50/20
UGR C0/C180		20.8
UGR C90/C270		27.2
CIE Flux Codes		64 90 98 100 100
Ra/CRI		>80

LTS

LK-L 060.11840.1125.1/DALI

Lichtkanal 060 | Light-Insert (AOV-001/003/005.1, 1xLED 26W 840/4000K 4010lm)

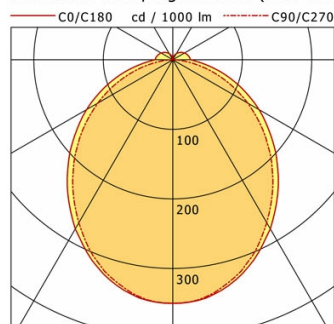

	C0	C90	C180	C270
0°	350	350	350	350
15°	332	328	332	328
30°	281	271	281	271
45°	213	200	213	200
60°	143	125	143	125
75°	75	51	75	51
90°	26	1	26	1

cd / 1000 lm

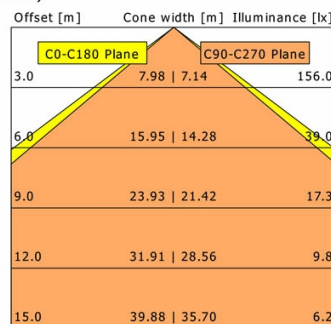

η		LED
Efficiency		154 lm/W
Direct/Indirect		↓ 93% / ↑ 7%
System Power		26 W
UGR		X=4H, Y=8H
Reflection factors		70/50/20
UGR C0/C180		27.5
UGR C90/C270		25.7
CIE Flux Codes		48 78 94 93 100
Ra/CRI		>80

LTS

LK-L 060.11840.1125.1/DALI

LK-L 060.11840.1125.1/DALI

Lichtkanal 060 | Light-Insert (Opal Diffuse, 1xLED 26W 840/4000K 4050lm)

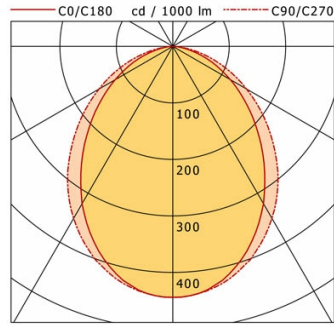

	C0	C90	C180	C270
0°	444	444	444	444
15°	410	419	410	419
30°	322	351	322	351
45°	212	254	212	254
60°	118	151	118	151
75°	42	59	42	59
90°	0	0	0	0

cd / 1000 lm

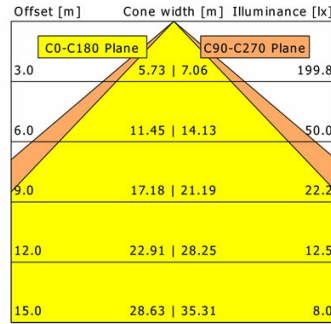

η	LED
Efficiency	156 lm/W
Direct/Indirect	↓ 100% / ↑ 0%
System Power	26 W
UGR	X=4H, Y=8H
Reflection factors	70/50/20
UGR C0/C180	25.1
UGR C90/C270	26.4
CIE Flux Codes	54 84 97 100 100
Ra/CRI	>80

LTS

LK-L 060.11840.1125.1/DALI

Lichtkanal 060 | Light-Insert (Deep Beam nanoOptix, 1xLED 26W 840/4000K 4220lm)

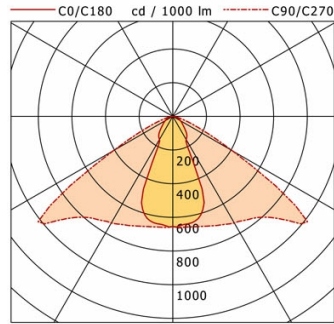

	C0	C90	C180	C270
0°	655	655	655	655
15°	618	677	618	677
30°	159	732	159	732
45°	98	853	98	853
60°	53	410	53	410
75°	25	45	25	45
90°	0	0	0	0

cd / 1000 lm

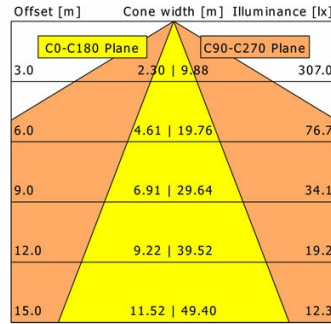

η	LED
Efficiency	162 lm/W
Direct/Indirect	↓ 100% / ↑ 0%
System Power	26 W
UGR	X=4H, Y=8H
Reflection factors	70/50/20
UGR C0/C180	20.8
UGR C90/C270	25.9
CIE Flux Codes	67 90 98 100 100
Ra/CRI	>80

LTS