

DCL-L 15.927.10

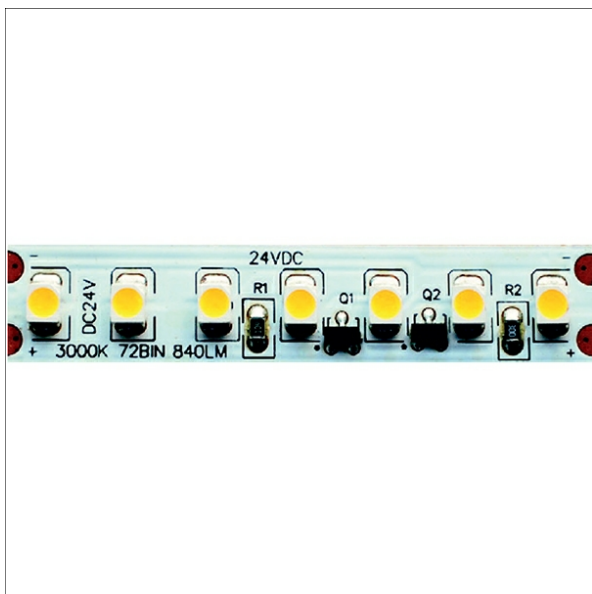

Farbe	Artikelnummer	EAN
	663828	4043544793409

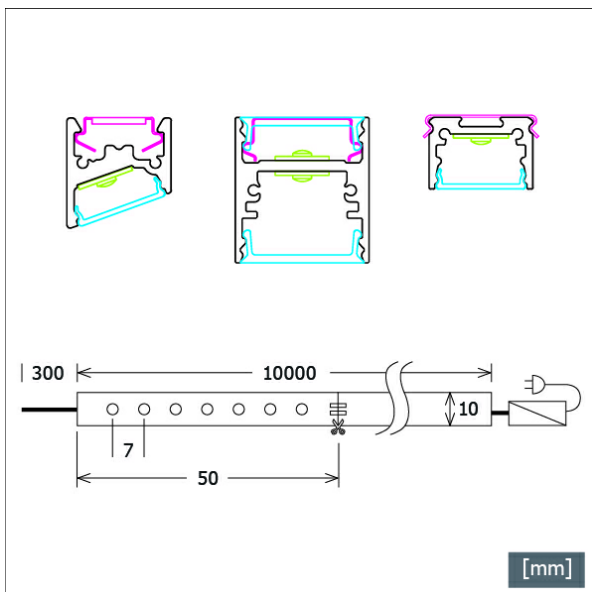

Beschreibung

- LED-Lichtband (Länge: 10 m) auf Rolle
- 140 LEDs pro Meter
- keine UV- und Wärmestrahlung
- nahezu alle Lichtbandlängen realisierbar
- kürzbar alle 50 mm
- Klebmontage in Profil
- Direktanschluss an geeigneten Konverter über Einspeisung mit Schneidklemmen
- Betriebsgerät (LED-Konverter) separat bestellen (Platzierung extern)

Hinweise

Die Angaben für Systemleistung, Lichtstrom und Systemeffizienz gelten jeweils für 1000 mm. Stellen Sie sicher, dass die zulässige Temperatur am Tc-Punkt nicht überschritten wird. Verwenden Sie deshalb nur die dafür vorgesehenen DecoLine Profile.

Standardoptionen



Lichttechnik / Normen

Leuchtmittel	LED Band / CRI 90 / 2700 K
Lebensdauer	L80 B50 40.000 h
Systemleistung	18.0 W
Leuchten-Lichtstrom	max. 1130 lm
Systemeffizienz	47.22 lm/W
Moduleffizienz	105.00 lm/W
UGR Klasse	>28
Abstrahlwinkel	110°
Versorgungsspannung	24 V DC
Schutzklasse	III
Schutzart	IP20

Abmessungen / Gewichte

Länge	10000 mm
Breite	10 mm
Höhe	3 mm
Nettogewicht	0.34 kg
Bruttogewicht	0.36 kg

DCL-L 15.927.10

DCL-L 15.927.10

DecoLine | LED Strip (AOB-A1, 1xLED 18W 927/2700K 850lm)

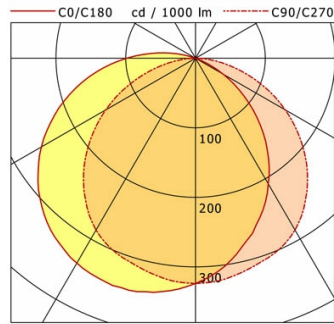

	C0	C90	C180	C270
0°	324	324	324	324
15°	275	311	347	311
30°	209	285	340	285
45°	128	226	309	226
60°	46	149	255	149
75°	0	65	182	65
90°	0	0	99	0
cd / 1000 lm				

LDC unsuitable for cone representation.
Asymmetric LDC.

η	LED
Efficiency	47 lm/W
Direct/Indirect	↓ 98% / ↑ 2%
System Power	18 W
UGR	X=4H, Y=8H
Reflection factors	70/50/20
UGR C0/C180	18.5
UGR C90/C270	27.9
CIE Flux Codes	45 75 92 98 100
Ra/CRI	>90

LTS

DCL-L 15.927.10

DecoLine | LED Strip (AKB-A1, 1xLED 18W 927/2700K 1130lm)

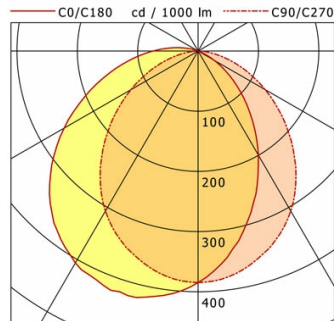

	C0	C90	C180	C270
0°	385	385	385	385
15°	302	362	423	362
30°	200	307	407	307
45°	104	221	348	221
60°	31	128	256	128
75°	0	49	157	49
90°	0	1	74	1
cd / 1000 lm				

LDC unsuitable for cone representation.
Asymmetric LDC.

η	LED
Efficiency	63 lm/W
Direct/Indirect	↓ 98% / ↑ 2%
System Power	18 W
UGR	X=4H, Y=8H
Reflection factors	70/50/20
UGR C0/C180	17.7
UGR C90/C270	27.8
CIE Flux Codes	49 79 94 98 100
Ra/CRI	>90

LTS

DCL-L 15.927.10

DecoLine | LED Strip (AOB-H1, 1xLED 18W 927/2700K 670lm)

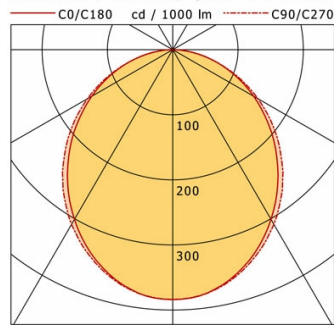

	C0	C90	C180	C270
0°	384	384	384	384
15°	361	363	361	363
30°	301	310	301	310
45°	224	235	224	235
60°	143	151	143	151
75°	65	65	65	65
90°	1	1	1	1
cd / 1000 lm				

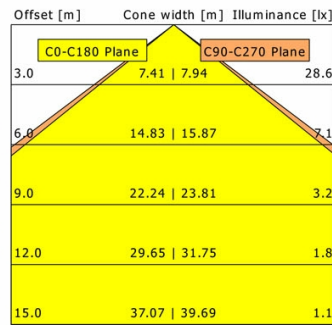

η	LED
Efficiency	37 lm/W
Direct/Indirect	↓ 100% / ↑ 0%
System Power	18 W
UGR	X=4H, Y=8H
Reflection factors	70/50/20
UGR C0/C180	26.9
UGR C90/C270	26.8
CIE Flux Codes	49 79 95 100 100
Ra/CRI	>90

LTS

DCL-L 15.927.10

DecoLine | LED Strip (AKB-H1, 1xLED 18W 927/2700K 990lm)

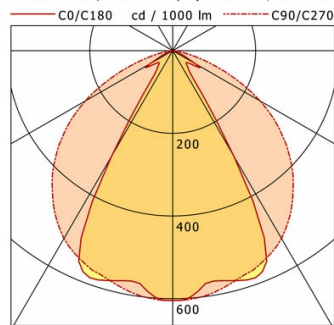

	C0	C90	C180	C270
0°	605	605	605	605
15°	576	577	576	577
30°	296	525	296	525
45°	47	409	47	409
60°	62	244	62	244
75°	10	59	10	59
90°	0	0	0	0
cd / 1000 lm				

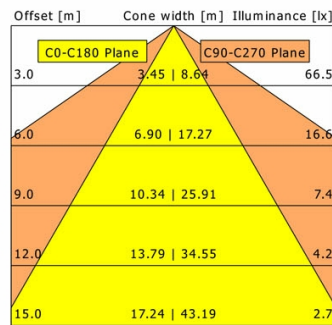

η	LED
Efficiency	55 lm/W
Direct/Indirect	↓ 100% / ↑ 0%
System Power	18 W
UGR	X=4H, Y=8H
Reflection factors	70/50/20
UGR C0/C180	19.5
UGR C90/C270	27.2
CIE Flux Codes	69 92 99 100 100
Ra/CRI	>90

LTS

DCL-L 15.927.10

DCL-L 15.927.10

DecoLine | LED Strip (AOV-H1, 1xLED 18W 927/2700K 720lm)

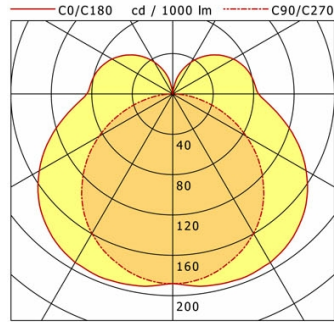

	C0	C90	C180	C270
0°	188	188	188	188
30°	193	160	193	160
60°	152	84	152	84
90°	85	1	85	1
120°	69	0	69	0
150°	36	0	36	0
180°	0	0	0	0
cd / 1000 lm				

LDC unsuitable for cone representation.
The C0 angle is oversized.

η	LED
Efficiency	40 lm/W
Direct/Indirect	↓ 77% / ↑ 23%
System Power	18 W
UGR	X=4H, Y=8H
Reflection factors	70/50/20
UGR C0/C180	29.7
UGR C90/C270	24.3
CIE Flux Codes	36 66 87 77 100
Ra/CRI	>90

LTS

DCL-L 15.927.10

DecoLine | LED Strip (AOB-U1, 1xLED 18W 927/2700K 710lm)

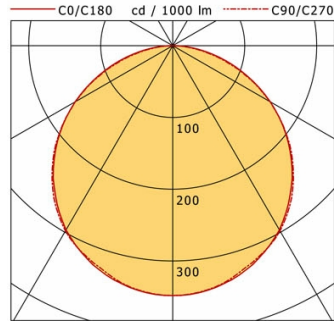

	C0	C90	C180	C270
0°	348	348	348	348
15°	335	332	335	332
30°	296	298	296	298
45°	234	236	234	236
60°	157	156	157	156
75°	72	68	72	68
90°	2	0	2	0
cd / 1000 lm				

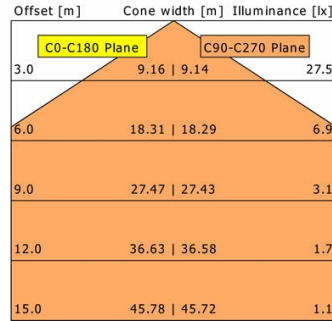

η	LED
Efficiency	39 lm/W
Direct/Indirect	↓ 100% / ↑ 0%
System Power	18 W
UGR	X=4H, Y=8H
Reflection factors	70/50/20
UGR C0/C180	27.6
UGR C90/C270	27.2
CIE Flux Codes	47 78 95 100 100
Ra/CRI	>90

LTS

DCL-L 15.927.10

DecoLine | LED Strip (AKB-U1, 1xLED 18W 927/2700K 990lm)

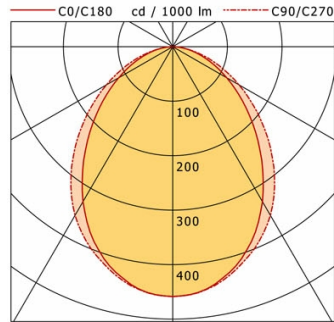

	C0	C90	C180	C270
0°	459	459	459	459
15°	423	428	423	428
30°	328	357	328	357
45°	211	250	211	250
60°	114	140	114	140
75°	45	52	45	52
90°	2	1	2	1
cd / 1000 lm				

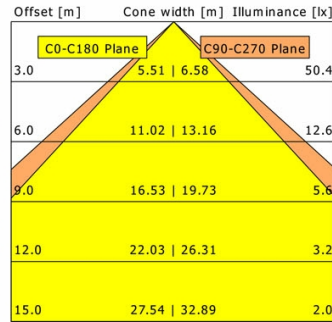

η	LED
Efficiency	55 lm/W
Direct/Indirect	↓ 100% / ↑ 0%
System Power	18 W
UGR	X=4H, Y=8H
Reflection factors	70/50/20
UGR C0/C180	26.5
UGR C90/C270	27.1
CIE Flux Codes	55 84 97 100 100
Ra/CRI	>90

LTS

DCL-L 15.927.10

Zubehör



CONV 024.035/DALI
LED-Konverter 35 W / dimmbar DALI



CONV 024.060
LED-Konverter 60 W / On-Off



CONV 024.060/DALI
LED-Konverter 60 W / dimmbar DALI



CONV 024.100
LED-Konverter 100 W / On-Off



CONV 024.100/DALI
LED-Konverter 100 W / dimmbar DALI



CONV 024.200
LED-Konverter 200 W / On-Off



DCL-Z100
Anschlussklemme



DCL-Z116
Verbinder elektrisch



DCL-Z117.1
Roller Standard

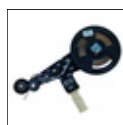

DCL-Z117.2
Roller Deluxe