

DCL-L 08.930.10

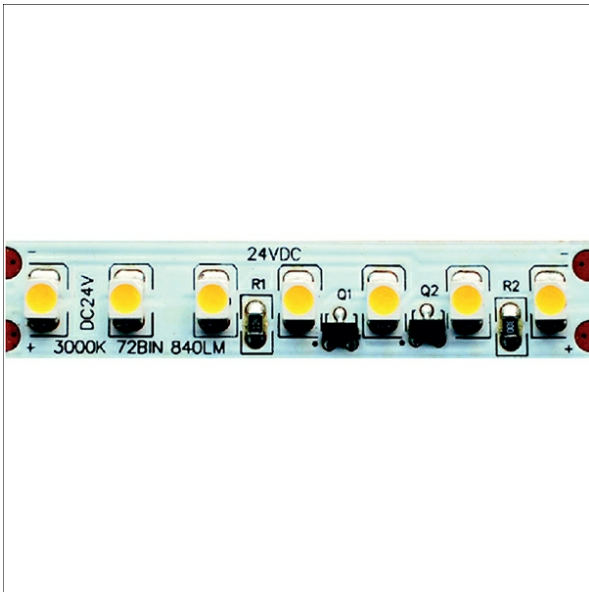

Farbe	Artikelnummer	EAN
	663826	4043544793386

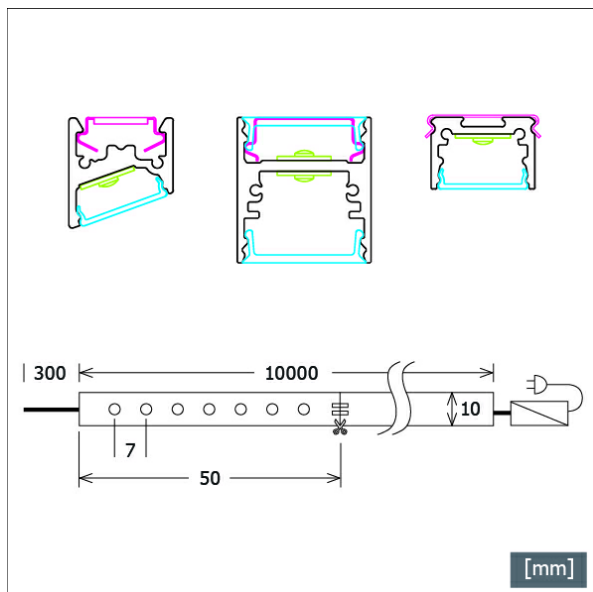

Beschreibung

- LED-Lichtband (Länge: 10 m) auf Rolle
- 140 LEDs pro Meter
- keine UV- und Wärmestrahlung
- nahezu alle Lichtbandlängen realisierbar
- kürzbar alle 50 mm
- Klebmontage in Profil
- Direktanschluss an geeigneten Konverter über Einspeisung mit Schneidklemmen
- Betriebsgerät (LED-Konverter) separat bestellen (Platzierung extern)

Hinweise

Die Angaben für Systemleistung, Lichtstrom und Systemeffizienz gelten jeweils für 1000 mm. Stellen Sie sicher, dass die zulässige Temperatur am Tc-Punkt nicht überschritten wird. Verwenden Sie deshalb nur die dafür vorgesehenen DecoLine Profile.

Standardoptionen



Lichttechnik / Normen

Leuchtmittel	LED Band / CRI 90 / 3000 K
EPREL Lichtquellen	1509014
Lebensdauer	L80 B50 40.000 h
Systemleistung	11.3 W
Leuchten-Lichtstrom	max. 650 lm
Systemeffizienz	43.36 lm/W
Moduleffizienz	105.00 lm/W
UGR Klasse	≤28
Abstrahlwinkel	110°
Versorgungsspannung	24 V DC
Schutzklasse	III
Schutzart	IP20

Abmessungen / Gewichte

Länge	10000 mm
Breite	10 mm
Höhe	3 mm
Nettogewicht	0.34 kg
Bruttogewicht	0.36 kg

DCL-L 08.930.10

DCL-L 08.930.10

DecoLine | LED Strip (AOB-A1, 1xLED 11W 930/3000K 490lm)

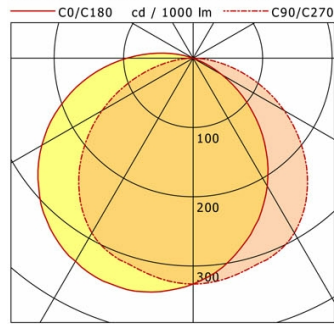

	C0	C90	C180	C270
0°	326	326	326	326
15°	279	314	347	314
30°	213	291	338	291
45°	132	232	307	232
60°	48	151	251	151
75°	0	66	179	66
90°	0	1	95	1
cd / 1000 lm				

LDC unsuitable for cone representation.
Asymmetric LDC.

η	LED
Efficiency	45 lm/W
Direct/Indirect	↓ 98% / ↑ 2%
System Power	11 W
UGR	X=4H, Y=8H
Reflection factors	70/50/20
UGR C0/C180	16.8
UGR C90/C270	26.0
CIE Flux Codes	45 75 92 98 100
Ra/CRI	>90

LTS

DCL-L 08.930.10

DecoLine | LED Strip (AKB-A1, 1xLED 11W 930/3000K 650lm)

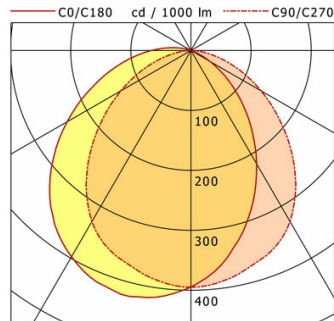

	C0	C90	C180	C270
0°	395	395	395	395
15°	321	374	423	374
30°	219	330	397	330
45°	117	236	333	236
60°	37	135	238	135
75°	0	51	143	51
90°	0	1	66	1
cd / 1000 lm				

LDC unsuitable for cone representation.
Asymmetric LDC.

η	LED
Efficiency	59 lm/W
Direct/Indirect	↓ 98% / ↑ 2%
System Power	11 W
UGR	X=4H, Y=8H
Reflection factors	70/50/20
UGR C0/C180	16.7
UGR C90/C270	25.8
CIE Flux Codes	50 80 94 98 100
Ra/CRI	>90

LTS

DCL-L 08.930.10

DecoLine | LED Strip (AOB-H1, 1xLED 11W 930/3000K 380lm)

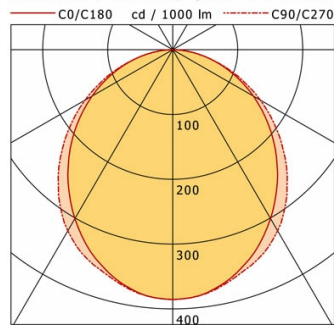

	C0	C90	C180	C270
0°	386	386	386	386
15°	361	365	361	365
30°	301	323	301	323
45°	225	246	225	246
60°	143	156	143	156
75°	65	66	65	66
90°	1	0	1	0
cd / 1000 lm				

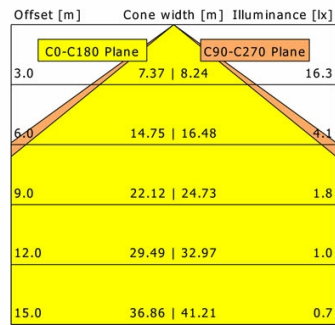

η	LED
Efficiency	35 lm/W
Direct/Indirect	↓ 100% / ↑ 0%
System Power	11 W
UGR	X=4H, Y=8H
Reflection factors	70/50/20
UGR C0/C180	24.9
UGR C90/C270	24.8
CIE Flux Codes	49 79 95 100 100
Ra/CRI	>90

LTS

DCL-L 08.930.10

DecoLine | LED Strip (AKB-H1, 1xLED 11W 930/3000K 570lm)

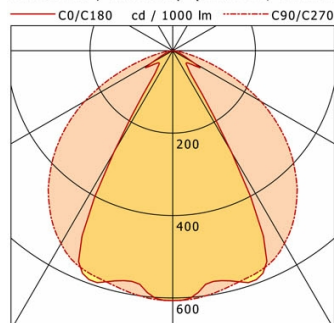

	C0	C90	C180	C270
0°	606	606	606	606
15°	579	585	579	585
30°	285	540	285	540
45°	47	420	47	420
60°	59	247	59	247
75°	10	59	10	59
90°	0	0	0	0
cd / 1000 lm				

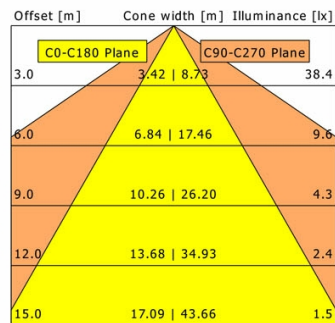

η	LED
Efficiency	52 lm/W
Direct/Indirect	↓ 100% / ↑ 0%
System Power	11 W
UGR	X=4H, Y=8H
Reflection factors	70/50/20
UGR C0/C180	17.4
UGR C90/C270	25.3
CIE Flux Codes	70 92 99 100 100
Ra/CRI	>90

LTS

DCL-L 08.930.10

DCL-L 08.930.10

DecoLine | LED Strip (AOV-H1, 1xLED 11W 930/3000K 400lm)

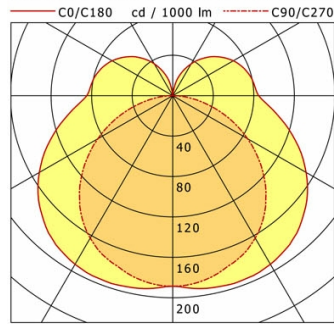

	C0	C90	C180	C270
0°	189	189	189	189
30°	193	163	193	163
60°	152	85	152	85
90°	85	1	85	1
120°	69	0	69	0
150°	36	0	36	0
180°	0	0	0	0
cd / 1000 lm				

LDC unsuitable for cone representation.
The C0 angle is oversized.

η	LED
Efficiency	36 lm/W
Direct/Indirect	↓ 77% / ↑ 23%
System Power	11 W
UGR	X=4H, Y=8H
Reflection factors	70/50/20
UGR C0/C180	27.6
UGR C90/C270	22.2
CIE Flux Codes	37 66 87 77 100
Ra/CRI	>90

LTS

DCL-L 08.930.10

DecoLine | LED Strip (AOB-U1, 1xLED 11W 930/3000K 400lm)

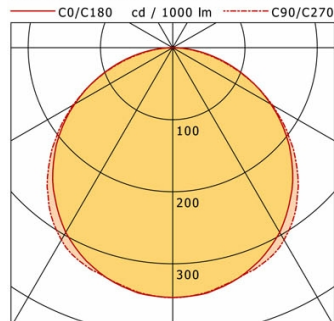

	C0	C90	C180	C270
0°	347	347	347	347
15°	334	334	334	334
30°	296	308	296	308
45°	234	244	234	244
60°	157	160	157	160
75°	73	69	73	69
90°	3	1	3	1
cd / 1000 lm				

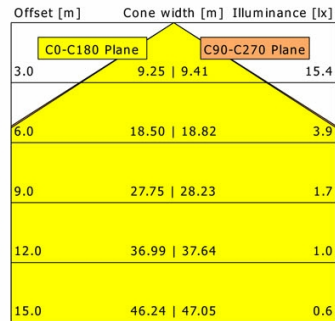

η	LED
Efficiency	36 lm/W
Direct/Indirect	↓ 100% / ↑ 0%
System Power	11 W
UGR	X=4H, Y=8H
Reflection factors	70/50/20
UGR C0/C180	25.7
UGR C90/C270	25.2
CIE Flux Codes	47 78 95 100 100
Ra/CRI	>90

LTS

DCL-L 08.930.10

DecoLine | LED Strip (AKB-U1, 1xLED 11W 930/3000K 560lm)

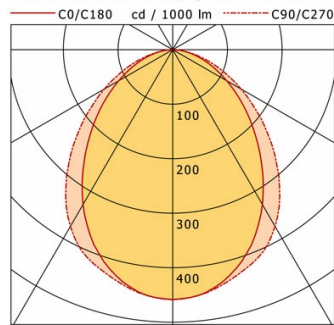

	C0	C90	C180	C270
0°	458	458	458	458
15°	423	433	423	433
30°	328	374	328	374
45°	210	261	210	261
60°	114	144	114	144
75°	46	54	46	54
90°	2	0	2	0
cd / 1000 lm				

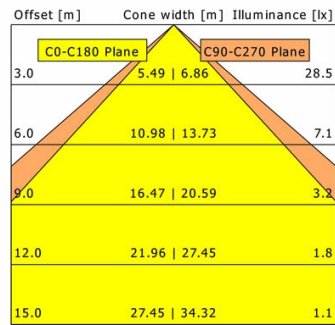

η	LED
Efficiency	51 lm/W
Direct/Indirect	↓ 100% / ↑ 0%
System Power	11 W
UGR	X=4H, Y=8H
Reflection factors	70/50/20
UGR C0/C180	24.5
UGR C90/C270	25.1
CIE Flux Codes	55 84 97 100 100
Ra/CRI	>90

LTS

DCL-L 08.930.10

Zubehör



CONV 024.035/DALI
LED-Konverter 35 W / dimmbar DALI



CONV 024.060
LED-Konverter 60 W / On-Off



CONV 024.060/DALI
LED-Konverter 60 W / dimmbar DALI



CONV 024.100
LED-Konverter 100 W / On-Off



CONV 024.100/DALI
LED-Konverter 100 W / dimmbar DALI



CONV 024.200
LED-Konverter 200 W / On-Off



DCL-Z100
Anschlussklemme



DCL-Z116
Verbinder elektrisch



DCL-Z117.1
Roller Standard

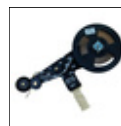

DCL-Z117.2
Roller Deluxe