

JAMIE 301.927.35.2/DALI-EU



Beschreibung

- flexibler Stromschienenstrahler in kompakter Bauform mit zylinderförmigem Design
- Leuchte 350° drehbar und 90° schwenkbar über integrierten Gelenkarm
- hohe Wartungsfreundlichkeit
- keine UV- und Wärmestrahlung
- Wärmemanagement über Gehäuse
- Spiegelreflektor aus Aluminium mit präziser symmetrischer Abstrahlcharakteristik für optimale Lichtausbeute und Entblendung
- Gehäusezylinder aus Aluminium
- Schutzglas klar
- 3-Phasen-Stromschienenadapter DALI (Eutrac)
- Betriebsgerät (LED-Konverter DALI, dimmbar) integriert

Standardoptionen

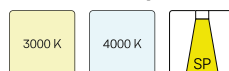

Sonderoptionen



Farbe	Artikelnummer	EAN
schwarz	657953	4043544668714
silber	657954	4043544668721
weiß	657955	4043544668738

Lichttechnik / Normen

Leuchtmittel	LED Spot / CRI 90 / 2700 K
EPREL Lichtquellen	848120
Lebensdauer	L90 B50 50.000 h L80 B50 100.000 h L80 B20 50.000 h
Systemleistung	16.0 W
Leuchten-Lichtstrom	1270 lm
Systemeffizienz	79.37 lm/W
Moduleffizienz	127.18 lm/W
UGR Klasse	≤19
Abstrahlbereich	Medium Flood
Abstrahlwinkel	31°
Versorgungsspannung	220 - 240 V / 50 - 60 Hz
Schutzklasse	I
Schutzart	IP20

Abmessungen / Gewichte

Länge	125 mm
Breite	80 mm
Höhe	215 mm
Durchmesser Lichtkopf	80 mm
Nettogewicht	0.90 kg
Bruttogewicht	1.00 kg

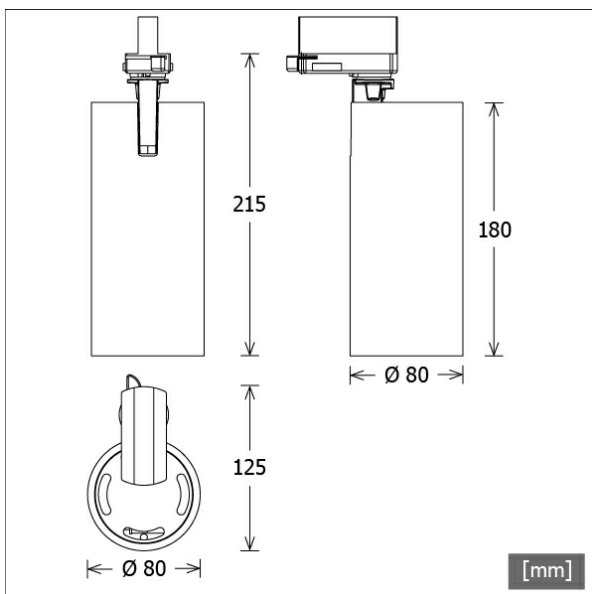

JAMIE 301.927.35.2/DALI-EU

Jamie 300 (1xLED 16W 927/2700K 1270lm 35 °)

C0/C180 cd / 1000 lm

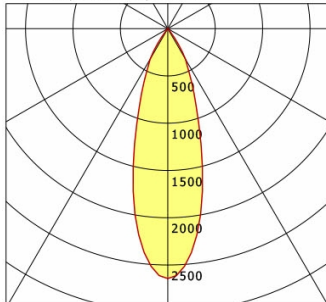

	C0	C90	C180	C270
0°	2643	2643	2643	2643
15°	1389	1389	1389	1389
30°	372	372	372	372
45°	14	14	14	14
60°	8	8	8	8
75°	5	5	5	5
90°	0	0	0	0
cd / 1000 lm				

Offset [m] Cone width [m] Illuminance [lx]

Offset [m]	Cone width [m]	Illuminance [lx]
3.0	1.68	373.0
6.0	3.35	93.2
9.0	5.03	41.4
12.0	6.70	23.3
15.0	8.38	14.9

η	LED
Efficiency	80 lm/W
Direct/Indirect	↓ 100% / ↑ 0%
System Power	16 W
UGR	X=4H, Y=8H
Reflection factors	70/50/20
UGR C0/C180	17.4
UGR C90/C270	17.4
CIE Flux Codes	97 99 100 100 100
Ra/CRI	>90

LTS

Zubehör



ZBK 12
Blendklappe



ZBW 85
Wabenraster