

JETT-T 102.927.MF/DALI-ST



Beschreibung

- flexibler Stromschienenstrahler in getrennter Bauform mit zylinderförmigem Lichtkopf
- Leuchte 355° drehbar und Lichtkopf 180° schwenkbar
- hohe Wartungsfreundlichkeit
- keine UV- und Wärmestrahlung
- Lichtkopf aus Aluminiumdruckguss
- innovatives Wärmemanagement mit formintegrierter Passivkühlung
- High-Performance Spiegelreflektor aus Aluminium mit präziser symmetrischer Abstrahlcharakteristik für optimale Lichtausbeute und Entblendung
- Gehäuse für Betriebsgerät aus Stahlblech
- Schutzglas klar
- 3-Phasen-Stromschienenadapter DALI (ONTrack)
- Betriebsgerät (LED-Konverter DALI, dimmbar) integriert

Standardoptionen



Sonderoptionen



Farbe	Artikelnummer	EAN
silber	668381	4043544800428
schwarz	668382	4043544800435
weiß	668383	4043544800442

Lichttechnik / Normen

Leuchtmittel	LED Spot / CRI 90 / 2700 K
EPREL Lichtquellen	1115627
Lebensdauer	L90 B50 50.000 h L80 B50 100.000 h L80 B20 50.000 h
Systemleistung	17.3 W
Leuchten-Lichtstrom	2260 lm
Systemeffizienz	130.63 lm/W
Moduleffizienz	134.07 lm/W
UGR Klasse	≤19
Abstrahlbereich	Medium Flood
Abstrahlwinkel	23°
Versorgungsspannung	220 - 240 V / 50 - 60 Hz
Schutzklasse	I
Schutzart	IP20

Abmessungen / Gewichte

Länge	154 mm
Breite	103 mm
Höhe	177 mm
Durchmesser Lichtkopf	103 mm
Nettogewicht	1.31 kg
Bruttogewicht	1.38 kg

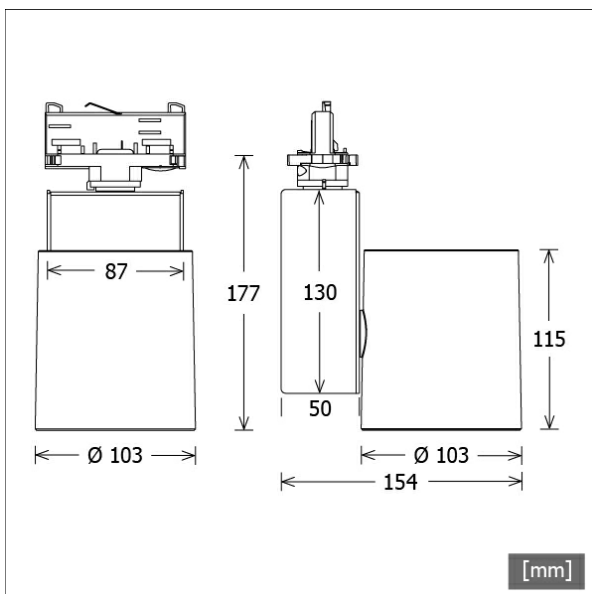

JETT-T 102.927.MF/DALI-ST

JETT-T 102.927.MF/DALI-ST

Jett Evo | Track-Mounted (1xLED 17W 927/2700K 2260lm 23°)

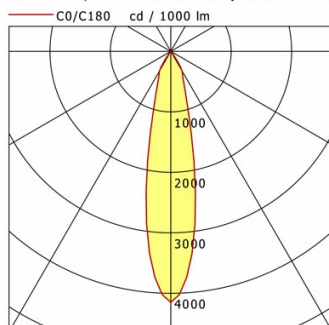

	C0	C90	C180	C270
0°	4149	4149	4149	4149
15°	1223	1223	1223	1223
30°	374	374	374	374
45°	14	14	14	14
60°	5	5	5	5
75°	1	1	1	1
90°	0	0	0	0
cd / 1000 lm				

Offset [m]	Cone width [m]	Illuminance [lx]
3.0	1.18	1041.9
6.0	2.36	260.5
9.0	3.53	115.8
12.0	4.71	65.1
15.0	5.89	41.7

η	LED
Efficiency	133 lm/W
Direct/Indirect	↓ 100% / ↑ 0%
System Power	17 W
UGR	X=4H, Y=8H
Reflection factors	70/50/20
UGR C0/C180	16.8
UGR C90/C270	16.8
CIE Flux Codes	98 100 100 100 100
Ra/CRI	>90

LTS

Zubehör



FOCUS 100.1
fokussierbare Bikonvexlinse für Akzentbeleuchtung



ST-A 10/9000A-1-ST
Anbau-Stromschiene ONTrack Advance mit Datenbus
(Länge: 1000 mm)



ST-A 20/9000A-2-ST
Anbau-Stromschiene ONTrack Advance mit Datenbus
(Länge: 2000 mm)



ST-A 30/9000A-3-ST
Anbau-Stromschiene ONTrack Advance mit Datenbus
(Länge: 3000 mm)



ST-A 40/9000A-4-ST
Anbau-Stromschiene ONTrack Advance mit Datenbus
(Länge: 4000 mm)



ST-A MONO/9000-BPU-D
3-Phasen-Anbau-Monopoint mit Busoption



ST-E 10/9000-1-R
Einbau-Stromschiene ONTrack mit Datenbus
(Länge: 1000 mm)



ST-E 20/9000-2-R
Einbau-Stromschiene ONTrack mit Datenbus
(Länge: 2000 mm)



ST-E 30/9000-3-R
Einbau-Stromschiene ONTrack mit Datenbus
(Länge: 3000 mm)



ST-E 40/9000-4-R
Einbau-Stromschiene ONTrack mit Datenbus
(Länge: 4000 mm)



ST-E MONO/9000-BPU-D
3-Phasen-Einbau-Monopoint mit Busoption



ZB-OR DONGLE
Organic Response IR-Dongle-Set

JETT-T 102.927.MF/DALI-ST

Zubehör



ZB-OR GATEWAY
Organic Response IoT-Gateway Kaskadenserie



ZB-OR-T SENSOR
Organic Response Sensor für
Stromschienenmontage



ZBK 96
Blendklappe



ZBW 83
Wabenraster